

EcoWater report

Proceedings of the 1st targeted event – Research links



University of Applied Sciences and Arts Northwestern Switzerland
School of Life Sciences



Author: Deltares, Case study partners

Funded by: Collaborative Research Project of the 7th Framework Programme

Report number: C 94

Edition: Only available as PDF for individual printing

© IVL Swedish Environmental Research Institute 2015

IVL Swedish Environmental Research Institute Ltd.,

P.O Box 210 60, S-100 31 Stockholm, Sweden

Phone: +46-8-598 563 00 Fax: +46-8-598 563 90

www.ivl.se

This report has been reviewed and approved in accordance with IVL's audited and approved management system.

This report is a deliverable or other report from the EU project
EcoWater.

At project closure it is was also published in IVL's C-series,
available from the IVL web-site.

The EcoWater project was conducted by an international consortium coordinated by NTUA (National Technical University of Athens). IVL participated in the R & D work, in addition to leading one of the industrial case studies (Volvo Trucks), represented by Volvo Technology.

EcoWater ran 2011-2014. The project is presented in more detail on

<http://environ.chemeng.ntua.gr/ecoWater/>

The project website holds a complete repository of all public deliverables from the EcoWater project.

Persons from IVL involved in EcoWater were:

Åsa Nilsson
Sara Skenhall
Magnus Klingspor
Tomas Rydberg
Uwe Fortkamp
Felipe Oliveira
Lina Danielsson
Elisabeth Hallberg

Contact person: Åsa Nilsson asa.nilsson@ivl.se

For Deliverables, please see additional information on this specific report on the subsequent Document Information page.



Meso-level eco-efficiency indicators to assess technologies and their uptake in water use sectors

Collaborative project, Grant Agreement No: 282882

Deliverable 6.3

Proceedings of the 1st targeted event Research links

how to achieve more with less

(EcoWater at the AquaConSoil conference)

April 30th, 2012

DOCUMENT INFORMATION

| Project | |
|--------------------------------|---|
| Project acronym: | EcoWater |
| Project full title: | Meso-level eco-efficiency indicators to assess technologies and their uptake in water use sectors |
| Grant agreement no.: | 282882 |
| Funding scheme: | Collaborative Project |
| Project start date: | 01/11/2011 |
| Project duration: | 36 months |
| Call topic: | ENV.2011.3.1.9-2: Development of eco-efficiency meso-level indicators for technology assessment |
| Project web-site: | http://environ.chemeng.ntua.gr/EcoWater |
| Document | |
| Deliverable number: | 6.3 |
| Deliverable title: | Proceedings of the 1st targeted event Research links |
| Due date of deliverable: | January 31 st 2013 |
| Actual submission date: | April 30 th 2013 |
| Editor(s): | Michiel Blind |
| Author(s): | Michiel Blind |
| Reviewer(s): | Dionysis Assimacopoulos, Mladen Todorovic, Åsa Nilsson, Christoph Hugi |
| Work Package no.: | 6 |
| Work Package title: | Dissemination, communication and science-policy links |
| Work Package Leader: | Michiel Blind |
| Dissemination level: | PU |
| Version: | 1 |
| Draft/Final: | |
| No of pages (including cover): | 62 |
| Keywords: | AquaConSoil, Eco-efficiency policy, Indicator development, Technology selection |

Abstract

The present document is the proceedings of the EcoWater scientific event, which took place as a one-day side event during the AquaConSoil 2013 conference.

The two key objectives of the meeting were:

1. Present Ecowater and expose the project to scientific peers, discussing concepts and results so far;
2. Learn from other projects / initiatives to enrich the EcoWater development.

The conference was organized in 4 slots, which were kept independent to allow for the audience to attend only selected sessions if desired.

This scientific event has been very valuable for the EcoWater project. The project has received substantial input through the presentations of the invited speakers, and by discussing the specificities of the project with them and among the partners. As a result, stronger interactions may be anticipated between all on-going initiatives, including UNEP Resource Efficiency, Eco-Innova, EmlInn, and the ETV pilot programme. In particular, the European efforts can possibly benefit more from each other's presence than achieved so far.

Contents

| | |
|--|----|
| DOCUMENT INFORMATION..... | 2 |
| Abstract..... | 3 |
| Contents..... | 4 |
| 1 Introduction | 5 |
| 2 Summary / conclusions per session | 6 |
| 2.1 (Meso-level) Eco-efficiency: concepts and relevance | 6 |
| 2.2 Meso-level eco-efficiency indicators: analysis, examples and calculation tools | 7 |
| 2.3 Facilitating wise technology decision making: technology assessment, scenario's and stakeholders | 8 |
| 2.4 Assessing/comparing eco-efficiency of your (agricultural) technology | 10 |
| 3 Concluding remarks | 10 |

1 Introduction

The EcoWater (EU FP7 Project) develops indicators, methodologies and analytical tools to assess eco-efficiency of water use by different sectors at the meso-level. Eco-efficiency looks at how more value can be achieved with less environmental pressure, while the meso-level deals with the level of analysis; the water system, where interdependent dynamics occur among heterogeneous actors. Several dissemination events are foreseen within the project, one of which targeting scientific peers is the subject matter of these proceedings.

Due to the fact that a project alone is rarely able to attract a large audience, EcoWater sought to develop a significant, one day side event during a major scientific conference. Taking the project's progress and requirements into account, the AquaConSoil conference was selected for the purpose. The one-day side event took place on April 18th 2013 in Barcelona. More information on AquaConSoil can be found at www.aquaconsoil.org/

The two key objectives of the EcoWater side event were to:

1. Present Ecowater and expose the project to scientific peers, discussing concepts and results so far;
2. Learn from other projects / initiatives to enrich our own development.

The conference was organized in 4 slots, which were kept independent to allow for the audience to attend parts of the day.

1. (Meso-level) Eco-efficiency: concepts and relevance;
2. Meso-level eco-efficiency indicators: analysis, examples and calculation tools;
3. Facilitating wise technology decision making: technology assessment, scenario's and stakeholders;
4. Assessing/comparing eco-efficiency of your (agricultural) technology.

Several external experts accepted the invitation to speak during the event.

This document provides a short summary of main conclusions per session (chapter 0) followed by some overall concluding remarks 3.

The main body of the report consists of:

- Annex A: Conference Programme (short)
Annex B: Annotated Conference Programme
Annex C, D, E: Presentations of session 1, 2 and 3.

Finally, a case study leaflets and two posters have been produced for the conference, published as a booklet. The booklet can be downloaded at: <http://environ.chemeng.ntua.gr/ecoWater/Default.aspx?t=171>

2 Summary / conclusions per session

2.1 (Meso-level) Eco-efficiency: concepts and relevance

Dionysios Assimacopoulos (NTUA, Greece) kicked off the meeting welcoming the participants. He explained the objectives, the challenges and the approach of EcoWater. Eco-efficiency is closely related to the decoupling philosophy, to resource efficiency, to 'doing more with less'. He pointed out that the water service system is essential in society, making water a very relevant subject for studying eco-efficiency.

Maite Aldaya (UNEP) introduced the water resource efficiency perspective of UNEP. She reminded the audience that under an average economic growth scenario and if no efficiency gains are assumed, global demand to withdraw water would outstrip currently accessible water supplies by 40% by 2030. The importance of ecosystems water need was highlighted. Financial aspects (subsidies not encouraging water efficiency, capital availability) are amongst the key barriers for improving water efficiency.

Robbert Droop (Ministry of Infrastructure and the Environment, The Netherlands), provided a thorough introduction to eco-innovation, first pointing out that implementing innovations results in significant economic benefits. Mentioning several examples where new value chains were developed or existing chains were significantly changed, the question on the table was 'how to change the (value) chain'. The Eco-innova ERA-net aims at achieving higher levels of system change, which is defined as radical innovation with positive (economic, environmental, societal) impact. New collaborations between currently not connected values chains are essential.

Per Mickwitz (Syke, Finland), explained that the dominant way of dealing with environmental problems is to set limits on emissions, waste, chemicals, growth: a negative approach. He argued that a positive approach, a green economy concept could provide a (politically) new framing of sustainability, climate & environmental policy leading to the radical transformation of consumption and production systems (socio-technical) are required. Within the Finnish region of Kymenlaakso the development and use of locally supported meso-level eco-efficiency indicators was demonstrated. This has been a huge success, as eco-efficiency remains very prominent in the regions policy. A cornerstone for this success was the stakeholder based process leading to the indicators.

Christoph Hugi (FHNW, Switzerland) elaborated on the concept of meso-level eco-efficiency within the EcoWater project. He made it clear that micro- and macro level analysis do not always pave the way for the most eco-efficient decisions. They can even create barriers. In a value chain different stakeholders need to collaborate and possibly to negotiate to create the highest added value.

In the subsequent discussions the point to involve the stakeholders (including users) in issues regarding eco-efficiency and eco-innovation was repeatedly voiced. Local

solutions, taking into account the local habits, are required when it comes to eco-innovation.

2.2 Meso-level eco-efficiency indicators: analysis, examples and calculation tools

Tomas Rydberg (IVL, Sweden) presented the progress made in EmlInn (Environmental Macro Indicators for Innovation), a sister project of EcoWater, running largely in parallel. He pointed out that the importance lies in the macro-economic effect of micro-level eco-innovation. Based on ex ante analysis in five case studies, the project aims to deliver a policy relevant ability to monitor the environmental impact of eco-innovation at the macro-level. Thomas Rydberg emphasized the use of already recognized indicators, presenting key criteria for selection. Interestingly, the project links to the DPSIR framework (http://root-devel.ew.eea.europa.eu/ia2dec/knowledge_base/Frameworks/doc101182), by selecting specifically indicators that focus on both the Pressure 'P' where links can be made to both economic activities and to environmental impacts.

Michiel Blind (Deltares, The Netherlands) focused on the role and identification of environmental impact indicators within the EcoWater project. He pointed out that indicators are relevant at various stages of the case study development. While he emphasized that good use should be made of established indicators, it is important that stakeholders feel comfortable with the indicators. Also, existing indicators on water resources (abstraction, depletion) are frequently scientifically debated. As a result 'open indicators' are used within EcoWater.

Rodrigo Maia (FEUP, Maia) brought theory to practice by demonstrating many of the concepts discussed by Christoph Hugi and Michiel Blind on the Monte Novo Case study. Eco-efficiency assessment in agriculture, for a certain area, concerns the comparison of the economic added value due to the production of irrigated crops, with the environmental impacts caused during that process. Rodrigo Maia showed the results of meso-level systems analysis, followed by numerical examples of eco-efficiency indicators. He concluded with some insight in the technologies and policies which will be analyzed on their eco-efficiency merits.

George Arampatzis presented the digital tools developed in EcoWater. Two stand-alone tools are developed to carry out computations on the economic and on the environmental part: (1) SEAT - Systemic Environmental Analysis Tool. This tool evaluates flows of resources and emissions for environmental indicators. (2) EVAT - Economic Value Added Analysis Tool. This tool evaluates the value added from water use across the water value chain. The web-based EcoWater toolbox assists the holistic evaluation of eco-efficiency and the assessment of innovative technology scenarios in water use systems.

In the discussion that followed it was reiterated that indicator selection should on one hand make the best use of existing, proven indicators, but on the other hand should be stakeholder-involved. Regarding proven indicators, the EcoWater partners were

made aware of the Dutch ReCiPe initiative, a project in which both midpoint and endpoint indicators for Life Cycle Impact Assessment (LCIA). are modelled. The models could in particular be useful for the toolbox (<https://sites.google.com/site/lciarecipe/home>).

Regarding the stakeholder process two important points were made: (1) the selection of the relevant stakeholders deserves sufficient attention. (2) Even if the stakeholder process leads to well-established proven indicators, this does not mean that this step can be omitted. Local ownership of the indicators is key to success.

The EcoWater view not to strive for an index, but to focus on the level of indicators as presented by Michiel Blind was supported: “there is a danger in aggregating too far. Having only one indicator you will lose transparency”. On the other hand, at least a discussion on the importance of the individual indicators and the significance of the differences is required to decide on technologies which have very different effects on different indicators.

At the end of the day, indicators can be called successful if (1) they have been used and continues to be used after the project; and (2) if they assisted in transforming the system to something better than before.

With respect to the tools the issue of alternative tools came up, the EcoWater project did assess several alternative tools¹, deciding to develop tools within the project to maintain flexibility and control.

The issue was raised if the methods and tools developed are adequate for the types of systemic system changes presented by Robbert Droop. These changes typically included entirely new products or extended value chains, including new stakeholders. While the EcoWater tools will allow analysing the changes in eco-efficiency, the types of systemic changes are not well represented within the EcoWater case studies.

2.3 Facilitating wise technology decision making: technology assessment, scenario's and stakeholders

Åsa Nilsson discussed the technology inventory and assessment within the project. She explained that within the project, technologies are relevant within the full range of the water supply and service value chain. A generic structure for a technology inventory has been implemented, and information on many technologies will be collected over the coming months. As a result a library of technology reference data based on 8 Case Studies, within Agricultural, Urban and Industrial water use applications will be established.

Palle Lindgaard-Jørgensen (DHI, Denmark) presented the role of scenarios in technology decisions. Two types of scenarios are distinguished: (1) Technology scenarios to assess Eco-efficiency = economic value created by use of water divided

¹ Deliverable 1.4 Review of existing frameworks and tools for developing eco-efficiency indicators.
([http://environ.chemeng.ntua.gr/ecowater/UserFiles/files/D1_4_Review_of%20existing_frameworks_and_tools_for_developing_eco-efficiency_indicators\(1\).pdf](http://environ.chemeng.ntua.gr/ecowater/UserFiles/files/D1_4_Review_of%20existing_frameworks_and_tools_for_developing_eco-efficiency_indicators(1).pdf))

by the impact and understanding interactions among actors in the value chain (2) Future scenarios to analyse different plausible futures and what influences decisions on uptake of eco-efficient technologies. Palle Lindgaard-Jørgensen focused on using the PESTLE² framework, to assess drivers and barriers for the uptake of technologies under alternative plausible futures.

Mladen Todorović (CIHEAM-MAI-Bari, Italy) brought the technology selection closer to the audience discussing it from the perspective of the agricultural case studies, and, in particular, on the experiences and preliminary results of the The Sinistra Ofanto Case Studying particular. He pointed out the importance of integration between engineering, ergonomic, environmental and socio-economic components of agricultural water system. Moreover, he emphasized that the multiplicative effect of water efficiency throughout the agricultural water supply chain implies that improvements are required in all steps. Important conclusions were that (1) Selection/Uptake of technologies ('plausible alternative futures') is site-specific and should consider both technical and PESTLE factors at both micro, meso and macro scale; and (2) Technologies should be applied/implemented/integrated at different scales (micro-farm, meso-district) having reciprocal relationship and multiplicative effects.

Thomas Track (Dechema, Germany) apprised the audience on the EU Environmental Technology Verification (ETV) Pilot Programme. ETV is to generate independent and credible information on new environmental technologies, by verifying that performance claims are complete, fair and based on reliable test results, in other words: 'It does what is says on the tin'. This is particularly important to bridge the gap between demonstration and market uptake. Beneficiaries of ETV are technology producers, technology purchasers / users, and policy-makers. It is particularly relevant within an international setting such as EU27, where a common ETV could significantly increase the uptake of new technologies.

The discussion following these presentations considered the interaction between (micro-level) ETV and meso-level eco-efficiency analysis. The technology inventories could be aligned, such that ETV technologies are available for meso-level eco-efficiency analysis. On the other hand meso-level analysis could give an extra edge to a convincing ETV story.

The potential of eco-labels on consumer-products was discussed briefly. The common opinion was that labelling would not strongly influence the uptake of eco-innovative technologies.

The point was made that sometimes simple changes in perspective and wording can overcome barriers: for example speaking about side-products instead of waste may spark innovative thinking. The water sector in the widest sense may benefit from a more positive vision for the sector, initiating a more innovative attitude.

² PEST analysis (Political, Economic, Social and Technological analysis) describes a framework of macro-environmental factors used in the environmental scanning component of strategic management. Some analysts added Legal and rearranged the mnemonic to SLEPT; inserting Environmental factors expanded it to PESTEL or PESTLE. (<http://en.wikipedia.org/wiki/PESTLE>)

2.4 Assessing/comparing eco-efficiency of your (agricultural) technology

This presentation consisted of a hands-on experience with the EcoWater tools. The audience logged on to the web-based toolbox and familiarized themselves with the different facilities, including uploading results from the SEAT and EVAT tool.

Guided by George Arampatzis, all participants successfully concluded the required steps and they could inspect the difference caused by a technology compared to the business as usual scenario.

3 Concluding remarks

While the overall AquaConSoil conference attendance was substantial, the external participation to the EcoWater side event was limited. While some improvements can certainly be made in preparation and advertisement, the main reason is likely that the 'scientific niche' the EcoWater project fills, which was further away from the scientific interest of the AquaConSoil audience than anticipated.

Be that as it may, the scientific event has been very valuable for the EcoWater project. The project has received enormous input through the presentations of the invited speakers, and by discussing the specificities of the project with the external participants and among the partners. As a result, stronger interactions can be anticipated among all ongoing initiatives, UNEP Resource Efficiency, Eco-Innova, EmInn, and the ETV pilot programme. The European efforts in particular can benefit more from each other's presence than achieved so far.

SESSION 1: (MESO-LEVEL) ECO-EFFICIENCY: CONCEPTS AND RELEVANCE

- 09:00 **Welcome and introduction to the EcoWater AquaConsoil Event.** By Dionysis Assimacopoulos (Session chair), National Technical University of Athens, Greece.
- 09:10 **Mainstreaming resource efficiency: UNEP Operational Strategy for Freshwater.** By Maite M. Aldaya, consultant, UNEP.
- 09:25 **From Environmental Technologies to System Innovation.** By Robbert Droop, Ministry of Infrastructure and the Environment, The Netherlands, and ECO-Innova.
- 09:40 **Meso-level eco-efficiency in Finland.** By Per Mickwitz, Finnish Environment Institute, Finland.
- 09:55 **The meso-level in the EcoWater Project.** By Christoph Hugli, Fachhochschule Nordwestschweiz, Switzerland .
- 10:10 **Discussion on the relevance of meso-level eco-efficiency analysis.**

SESSION 2: MESO-LEVEL ECO-EFFICIENCY INDICATORS: ANALYSIS, EXAMPLES AND CALCULATION TOOLS

- 11:00 **Introduction.** By Åsa Nilsson (chair) IVL Swedish Environmental Research Institute, Sweden.
- 11:05 **Environmental Indicators to measure and monitor impacts of innovation on the macro-scale.** By Tomas Rydberg, IVL Swedish Environmental Research Institute, Sweden.
- 11:20 **The EcoWater analytical approach for (meso –level) indicator development and technology assessment.** By Michiel Blind, Deltares, The Netherlands.
- 11:40 **Meso-level indicators in the Monte Novo Irrigation Scheme, Southern Portugal.** By Rodrigo Maia, Universidade do Porto Faculdade de Engenharia, Portugal.
- 12:00 **Discussion on indicator development**
- 12:20 **Tools to calculate meso-level Eco-efficiency indicators.** By George Arampatzis, National Technical University of Athens, Greece.

SESSION 3: FACILITATING WISE TECHNOLOGY DECISION MAKING: TECHNOLOGY ASSESSMENT, SCENARIO'S AND STAKEHOLDERS

- 14:00 **Introduction.** By Michiel Blind (chair), Deltares, The Netherlands.
- 14:05 **Overview of eco-innovative technologies in the EcoWater sectors.** By Åsa Nilsson, IVL Swedish Environmental Research Institute, Sweden.
- 14:20 **Scenarios to support eco-innovation decisions.** By Palle Lindgaard Jørgensen, DHI, Denmark.
- 14:35 **Assessing eco-innovative technologies in agriculture.** By Mladen Todorovic, CIHEAM – Mediterranean Agronomic Institute of Bari, Italy.
- 14:50 **Environmental Technology Verification.** By Thomas Track, Dechema, Germany.
- 15:05 **Discussion on decision support requirements.**

SESSION 4: ASSESSING/COMPARING ECO-EFFICIENCY OF YOUR (AGRICULTURAL) TECHNOLOGY

- 16:00 **Introduction.** By Mladen Todorovic, Mediterranean Agronomic Institute of Bari, Italy.
- 16:05 **The EcoWater tools and toolbox.** By George Arampatzis, National Technical University of Athens, Greece.
- 16:20 **Examples**
- 16:50 **Discussion**
- 17:15 **Closing of the event.** By Dionysis Assimacopoulos, National Technical University of Athens, Greece.

SESSION 1: (MESO-LEVEL) ECO-EFFICIENCY: CONCEPTS AND RELEVANCE

09:00 *Welcome and introduction to the EcoWater AquaConsoil Event. By Dionysis Assimacopoulos (Session chair), National Technical University of Athens, Greece.*

Abstract: The purpose of this session is to introduce the EcoWater project, and the concept of meso-level eco-efficiency.

EcoWater is a Research Project aiming to address the existing gap in meso-level eco-efficiency metrics by adopting a systems' approach to develop eco-efficiency indicators, using water service systems as case application examples. This presentation will try to illustrate the scope and the main concepts of the EcoWater project and analyse the methodological framework for the Case Study development. Emphasis will be given in the selection process of the eco efficiency indicators, their interpretation and their relevance to the meso-level.

About the presenter: Prof. Dionysis Assimacopoulos is the Coordinator of the EcoWater project. He is a professor at the Chemical Engineering School of the National Technical University of Athens and the coordinator of the Environmental & Energy Management Research Unit. He has participated in many research projects at both national and European/International level, as coordinator, principal investigator or scientific consultant. His research interests focus on environmental management and protection, water resources management, water supply in stressed areas, desalination, climate change adaptation, drought management, energy conservation & regional energy planning with renewable energy sources.

09:10 *Mainstreaming resource efficiency: UNEP Operational Strategy for Freshwater. By Maite M. Aldaya, consultant, UNEP.*

Abstract: Sustaining ecosystem services is fundamental to sustainable economic growth and human wellbeing. Virtually all of these services depend on water. This presentation analyses the efficiency of water use and the relationships between economic growth, water uses and related pollution. Under an average economic growth scenario and if no efficiency gains are assumed, global demand to withdraw water would outstrip currently accessible water supplies by 40% by 2030. The presentation examines the challenges and opportunities to improve efficiency and demonstrates that decoupling economic growth from water uses and water pollution is an essential strategy for heading off looming water resource limits to economic growth, human welfare and ecosystem services.

About the presenter: Maite Aldaya is a postdoctoral researcher at the Water Observatory and consultant for the Sustainable Consumption and Production Branch of the Division of Technology, Industry and Economics of the United Nations Environment Programme. Maite has a PhD in Ecology and MSc in Environmental Policy and Regulation from the London School of Economics and Political Science. She has worked in several international organizations such as the Agriculture and Soil Unit of the European Commission or the Land and Water Development Division of the Food and Agriculture Organization of the United Nations. She has developed her research on water accounting, footprint and efficiency at different organizations, such as the University of Twente (Netherlands), Complutense University of Madrid (Spain) or Technical University of Madrid (Spain).

09:25 *From Environmental Technologies to System Innovation. By Robbert Droop, Ministry of Infrastructure and the Environment, The Netherlands, and ECO-Innova.*

Abstract: Innovation for sustainability has a large gap to fill between environmental performance of society and ecosystem limitations. Still, full application of eco-innovation seems to fall short of the necessary response. Environmental pressures continue to rise due to a combination of reasons, and we stay far from achieving our substantive environmental objectives and targets. System innovation is the next step, and the question is how this could work out in the water sector.

About the Robbert Droop has been working for more than 25 years in different policy functions in the

presenter: Netherlands, the European Commission and the United Nations Environment Programme. The past 10 years he is in charge of the representation of Netherlands' interests in respect of the European research and innovation programme FP7, the European Eco-Innovation Action Plan, and the transnational cooperation Eco-Innova boosting eco-innovation through cooperation in research.

09:40 *Meso-level eco-efficiency in Finland. By Per Mickwitz, Finnish Environment Institute, Finland.*

Abstract: This presentation will discuss lessons learned of the various studies on meso-level eco-efficiency in Finland.

About the presenter: During the last years much of Prof. Mickwitz work has focused on the theory and practice of environmental policy evaluation. He has published several monographs and numerous articles in academic journals. He was one of the two editors of the issue "Environmental Program and Policy Evaluation: Addressing Methodological Challenges" of the journal New Directions for Evaluation that was published in June 2009. Recently the focus of my work has shifted to energy and climate policy issues. In 2008 Prof. Mickwitz was leading a team, which made the study "Mainstreaming and Coherence of Climate Policies" for the Finnish Prime Minister's office. I was also leader of the European research team that wrote the report "Climate Policy Integration, Coherence and Governance" which was published by the Partnership for European Environmental Research in March 2009. In 2009, Prof Mickwitz was appointed Guest-editor of a special issue of the Journal of Cleaner Production, the other members of the editorial team were Mikael Hildén, Jyri Seppälä and Matti Melanen. The title of the special issue, volume 19, issue 16, is "Promoting Transformation towards Sustainable Consumption and Production in a Resource and Energy Intensive Economy – the Case of Finland" and it was published in the autumn 2011.

09:55 *The meso-level in the EcoWater Project. By Christoph Hugi, Fachhochschule Nordwestschweiz, Switzerland .*

Abstract: The basic concept of meso-level eco-efficiency will be introduced for water supply-use-disposal and treatment systems considered in the EcoWater project. A case will be made why a meso-level view is required to enhance the overall eco-efficiency further, how we quantify eco-efficiency with indicators and what the main issues to consider are.

About the presenter: Prof. Dr. Christoph Hugi, University of Applied Sciences and Arts Northwestern Switzerland has extensive experience in river basin analysis and decision support in the water sector. Specific areas of research have been: assessments of the sustainability of micro-pollutant removal technologies, the planning and selection of road drainage systems, the sustainability analysis for lake restoration measures, a risk assessment for a drinking water well, strategic planning for a wastewater treatment facility, risk assessment for a sewage drainage system, trends and outlook analysis 2025 for the water use sectors in Switzerland. Within EcoWater, Christoph is leading the urban case studies

10:10 *Discussion on the relevance of meso-level eco-efficiency analysis.*

SESSION 2: Meso-level eco-efficiency indicators: analysis, examples and calculation tools

11:00 *Introduction. By Åsa Nilsson (chair) IVL Swedish Environmental Research Institute, Sweden.*

Abstract: Selecting the right indicators and identifying the appropriate means to aggregate underlying parameters is a very important issue. In this session various ways to select appropriate indicators and methods to combine parameters into indicators will be discussed.

About the presenter: Åsa Nilsson is a senior scientist within the area of process modelling and control. During her 12 years at IVL she has been involved in several projects that link industrial production process models with environmental performance measures. In the EcoWater project, Åsa leads the work on the industrial Case Study for Volvo and she is

| task-leader for the development of the Technology Inventory.

11:05 ***Environmental Indicators to measure and monitor impacts of innovation on the macro-scale. By Tomas Rydberg, IVL Swedish Environmental Research Institute, Sweden.***

Abstract: The EMInInn project is running parallel to Eco-water, but focusing on measuring impacts of innovation on the macro-level. The presentation will highlight the considerations discussed and findings achieved until now within EMInInn, in particular regarding environmental indicators.

About the presenter: Ph.D. Tomas Rydberg has worked more than 20 years on development and application of methods and indicators for environmental and economic performance assessment of process and product systems. He is currently leading the IVL team in the same area. Within EMInInn, Tomas is leading a workpackage on environmental indicators.

11:20 ***The EcoWater analytical approach for (meso –level) indicator development and technology assessment . By Michiel Blind, Deltares, The Netherlands.***

Abstract: Eco-efficiency is defined as the quotient of the economic added value (nominator) and environmental pressure (denominator). This presentation will focus on the choice and assessment of the environmental pressure. Starting from the step wise approach adopted in the EcoWater project, the essentials of selecting and calculating appropriate indicators will be elaborated.

About the presenter: For more than twelve years Michiel Blind has been working on European Research Projects. Whereas early work focussed on ICT and software, Michiel also worked on science policy interfacing, aiming to enhance the usefulness and the uptake of research results by practitioners. In FP7 AquaStress he implemented the tools for stakeholder driven water stress indicator implementation. Within EcoWater, Michiel is engaged in indicator development, tool development and he leads the dissemination work package.

11:40 ***Meso-level indicators in the Monte Novo Irrigation Scheme, Southern Portugal. By Rodrigo Maia, Universidade do Porto Faculdade de Engenharia, Portugal.***

Abstract: Focusing on agricultural case studies, this presentation demonstrates the application of meso-level ecoefficiency indicators for the agricultural sector, using Monte Novo Irrigation scheme case study as an example. A brief description is also included of the background supporting the preliminary results presented. At the end, the final objective to be achieved with the application of the meso-level ecoefficiency indicators is conceptually explained.

About the presenter: Prof. Rodrigo Maia holds a PhD in Civil Engineering and is Associate Professor at UPorto. He is currently the Vice-President of EWRA (European Water Resources Association). He has participated in several national and international projects, including the WaterStrategyMan (FP5), Aquastress (FP6) projects and is currently participating in EcoWater, DEWFORA and COROADO (FP7) projects. In EcoWater he is leading the development of the Case Study 2, focused on ecoefficiency in the Monte Novo Irrigation Scheme.

12:00 ***Discussion on indicator development***

12:20 ***Tools to calculate meso-level Eco-efficiency indicators. By George Arampatzis, National Technical University of Athens, Greece.***

Abstract: The EcoWater Toolbox is an integrated suite of on-line, web-accessed tools and resources for the assessment of the eco-efficiency of innovative technologies. This presentation will try to clarify the architecture of the toolbox and the integration of its components, to support the various phases of the EcoWater methodological framework. Emphasis is given on the EcoWater tools for the assessment of the environmental component of the eco-efficiency

indicators (Systemic Environmental Analysis Tool- SEAT) and the economic component of the eco-efficiency indicators (Economic Value chain Analysis Tool – EVAT). The SEAT addresses the water supply chain, its components, processes & interactions while the EVAT addresses the value chain, its actors and their interactions.

About the presenter:

George Arampatzis is a researcher at the Environmental & Energy Management Unit of the Chemical Engineering School of the National Technical University of Athens.

George has a PhD in Chemical Engineering. He has participated in many national and EC research projects related to energy and water resources management. His research interests focus on the modelling and optimisation of systems and processes, on the development and implementation of ICT applications.

Within EcoWater, George is mainly engaged in the design, development and testing of the EcoWater tools and the Ecowater Toolbox for meso-level eco-efficiency assessment and value chain analysis.

SESSION 3: FACILITATING WISE TECHNOLOGY DECISION MAKING: TECHNOLOGY ASSESSMENT, SCENARIO'S AND STAKEHOLDERS

14:00 *Introduction. By Michiel Blind (chair), Deltares, The Netherlands.*

Abstract: Selecting effective eco-technologies to increase the overall eco-efficiency is not a straightforward action. In particular on the technologies selected may adversely affect the entire eco-efficiency, or the ability to implement alternative technologies elsewhere in the system. Furthermore, the effectiveness of technologies may depend on the (future development of) drivers and barriers for uptake. In this session supporting technology decision making will be addressed.

About the presenter: For more than twelve years Michiel Blind has been working on European Research Projects. Whereas early work focussed on ICT and software, Michiel also worked on science policy interfacing, aiming to enhance the usefulness and the uptake of research results by practitioners. In FP7 AquaStress he implemented the tools for stakeholder driven water stress indicator implementation. Within EcoWater, Michiel is engaged in indicator development, tool development and he leads the dissemination work package.

14:05 *Overview of eco-innovative technologies in the EcoWater sectors. By Åsa Nilsson, IVL Swedish Environmental Research Institute, Sweden.*

Abstract: The presentation will show the EcoWater structure for a library of technology reference data and what kind of information is stored. The technology inventory is populated with data as work on the eight EcoWater Case Studies progresses. The presentation will give an overview on the current status on technologies for each Case Study and take a closer look at which innovative technologies are evaluated in the two agricultural Case Studies.

About the presenter: Åsa Nilsson is a senior scientist within the area of process modelling and control. During her 12 years at IVL she has been involved in several projects that link industrial production process models with environmental performance measures. In the EcoWater project, Åsa leads the work on the industrial Case Study for Volvo and she is task-leader for the development of the Technology Inventory.

14:20 *Scenarios to support eco-innovation decisions. By Palle Lindgaard Jørgensen, DHI, Denmark.*

Abstract: Dr. Palle Lindgaard-Jørgensen, DHI
Two types of scenarios support eco-innovation decisions in EcoWater. Technology scenarios are used to assess the eco-efficiency of a technology Future scenarios assess if a technology which is eco-efficient to-day is also likely to be eco-efficient in the future and how and by whom the future uptake of eco-efficient technologies can be influenced. The future scenario assessments are based on analyses of barriers and drivers for technology uptake in the PESTLE (Political, Economic, Social, Technological, Legal and Environmental).

About the presenter: For more than 20 years Dr Palle Lindgaard-Jørgensen has been working on European Research projects in the field of water resources management and sustainability assessments of water use. The work has involved development of indicators for sustainability and development of monitoring frameworks for water use as well as development of organisational frameworks promoting integrated approaches to use of water resources.

14:35 *Assessing eco-innovative technologies in agriculture. By Mladen Todorovic, CIHEAM – Mediterranean Agronomic Institute of Bari, Italy.*

Abstract: The presentation will focus on the eco-efficiency assessment of the pressurized irrigation schemes confronting the traditional and new technological applications including: a) introduction of multi-user hydrants equipped with electronic cards for monitoring and controlling water delivery at farm scale, b) use of variable speed pumps at the lifting stations; c) application of subsurface drip irrigation, d) cropping pattern modification, e) adoption of

regulated deficit irrigation strategies. A set of examples with the indicators assessing the eco-efficiency of agricultural water systems will be presented.

About the presenter:

Prof. Dr. Mladen Todorović, PhD, is a Civil Engineer (Hydro-technics) with PhD in Agrometeorology. He is Senior Scientific Officer and lecturer at CIHEAM-IAMB, and Visiting Professor at the University of Belgrade (Serbia). Experiences in hydrological and crop growth modelling, development of new technologies and DSS in water-environment sector, climate change studies, etc. Participation in the European Research Projects since 1993. Recent/on-going experiences: a) leader of WB on dissemination (AQUASTRESS, FP6- IP), b) leader of WP on Mediterranean strategic water sectors (WASSERMed, FP7-ENV) coordinator of ACLIMAS (EU-SWIM-DP).
Within EcoWater, Mladen is the leader of WP2 on the eco-efficiency assessment of agricultural water systems and responsible for the Sinistra Ofanto Case Study.

14:50 *Environmental Technology Verification. By Thomas Track, Dechema, Germany.*

Abstract: Environmental Technology Verification (ETV) is a new tool to help innovative environmental technologies reach the market. The problem at the moment is that many clever new ideas that can benefit environment and health are not taken up simply because they are new and untried. Under ETV, claims about innovative environmental technologies can be verified – if the 'owner' of the technology so wishes – by qualified third parties called 'Verification Bodies'. The 'Statement of Verification' delivered at the end of the ETV process can be used as evidence that the claims made about the innovation are both credible and scientifically sound. The EU Environmental Technology Verification pilot programme is trying out ETV on a large scale with volunteer organisations and Member States.

About the presenter:

Thomas Track holds a PhD in hydrogeology. He is senior researcher on responsible environmental technologies. Thomas Track has more than 15 years of experience in research and innovation management in sustainable industrial water management, soil and groundwater protection and environmental technology verification. In his actual position the focus is on innovation in industrial water management. This is linked with the position as is member of the technical expert group in the EC Environmental Technology Verification Pilot-Programme and as coordinator of the FP7 projects ChemWater and E4Water that have a strong link to innovation.

15:05 *Discussion on decision support requirements.*

SESSION 4: ASSESSING/COMPARING ECO-EFFICIENCY OF YOUR (AGRICULTURAL) TECHNOLOGY

16:00 *Introduction. By Mladen Todorovic, Mediterranean Agronomic Institute of Bari, Italy.*

Abstract: In this session the tools and their operations will be presented (hands-on). The demonstration will be based on the pre-lunch discussions in which specific request from the audience have been identified.

About the presenter: Prof. Dr. Mladen Todorović, PhD, is a Civil Engineer (Hydro-technics) with PhD in Agro-meteorology. He is Senior Scientific Officer and lecturer at CIHEAM-IAMB, and Visiting Professor at the University of Belgrade (Serbia). Experiences in hydrological and crop growth modelling, development of new technologies and DSS in water-environment sector, climate change studies, etc. Participation in the European Research Projects since 1993. Recent/on-going experiences: a) leader of WB on dissemination (AQUASTRESS, FP6- IP), b) leader of WP on Mediterranean strategic water sectors (WASSERMed, FP7-ENV) coordinator of ACLIMAS (EU-SWIM-DP).
Within EcoWater, Mladen is the leader of WP2 on the eco-efficiency assessment of agricultural water systems and responsible for the Sinistra Ofanto Case Study.

16:05 *The EcoWater tools and toolbox. By George Arampatzis, National Technical University of Athens, Greece.*

Abstract: The EcoWater toolbox is an integrated suite of on-line, web-accessed tools and resources for assessing meso-level eco-efficiency improvements from technology uptake in water systems. This presentation will be a live (hands-on) demonstration of the EcoWater tools and toolbox operation. The demonstration will follow the phases of the EcoWater methodological framework (Analysis of the Physical System, Baseline Eco-Efficiency Assessment, Identification of Innovative Technologies and Technology Scenario Assessment). A typical example will be presented and the role of the toolbox in supporting each analysis phase will be demonstrated.

About the presenter: George Arampatzis is a researcher at the Environmental & Energy Management Unit of the Chemical Engineering School of the National Technical University of Athens. George has a PhD in Chemical Engineering. He has participated in many national and EC research projects related to energy and water resources management. His research interests focus on the modelling and optimisation of systems and processes, on the development and implementation of ICT applications.
Within EcoWater, George is mainly engaged in the design, development and testing of the EcoWater tools and the Ecowater Toolbox for meso-level eco-efficiency assessment and value chain analysis.

16:20 *Examples*

16:50 *Discussion*

17:15 *Closing of the event. By Dionysis Assimacopoulos, National Technical University of Athens, Greece.*

Annex C: Presentations of session 1: (MESO-LEVEL) ECO-EFFICIENCY: CONCEPTS AND RELEVANCE

Presentation: *Welcome and introduction to the EcoWater AquaConsoil Event. By Dionysis Assimacopoulos (Session chair), National Technical University of Athens, Greece.*

EcoWater
AquaConsoil Conference Side event
April 18th 2013

Measuring and Enhancing Eco-efficiency in Water Use Sectors
The EcoWater project

Prof. Dionysis Assimacopoulos
School of Chemical Engineering
National Technical University of Athens, Greece

The EcoWater project

- Meso-level eco-efficiency indicators to assess technologies and their uptake in water use sectors
- Collaborative Research Project - supported by the 7th Framework Programme
 - Theme: ENV.2011.3.1.9-2 Development of eco-efficiency meso-level indicators for technology assessment
 - 1st November 2011 - 31st October 2014
- 10 Partners
 - 6 Universities, 3 Research Institutes, 1 SME

Project Goals and Objectives

- Goal
 - Development of eco-efficiency metrics at the meso-level
- Specific research objectives
 - Selection of eco-efficiency indicators
 - Integration of methods & tools for eco-efficiency assessment
 - Assessment of innovative technologies
 - Analysis of policy instruments that could foster technology uptake
- Water use sectors as case application examples
 - Water supply chains, Water service system

Project Goals and Scope

- Goal
 - Development of eco-efficiency metrics at the meso-level
- Specific research objectives
 - Selection of eco-efficiency indicators
 - Integration of methods & tools for eco-efficiency assessment
 - Assessment of innovative technologies
 - Analysis of policy instruments that could foster technology uptake
- Water use sectors as case application examples
 - Water supply chains, Water service system

Eco-efficiency: Concept & metrics

- Concept: Creating more economically valuable goods & services, while using fewer resources & creating less waste – pollution
 - "Doing more with less"
 - "Decoupling"
- Implication: Offering the most cost effective way of reducing environmental pressures / impacts

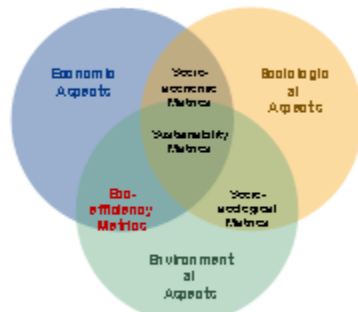

$$\text{Eco-efficiency metric} = \frac{\text{Economic output}}{\text{Environmental influence}}$$

Source: Sikder S.K., 2009

Water - Driving force

- Important input in most production processes
- Significant environmental impacts & economic costs of water purification processes
- Need for more holistic approaches in water systems analysis
- Uptake of water-related innovations remains primarily driven by regulations



EcoWater uses **water service systems** as case application examples

The Water Value Chain & the Meso-level System

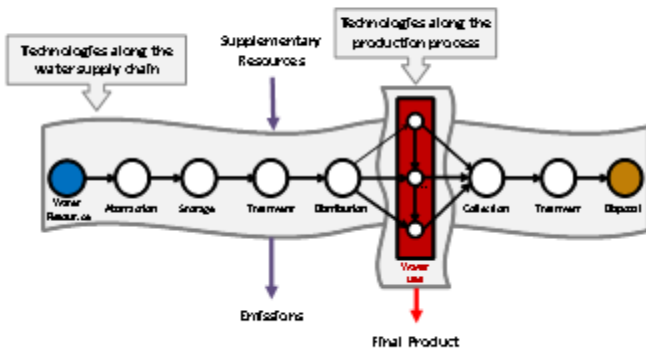

EcoWater Framework of Research

1. Mapping the water system
2. Identifying governance (key players)
3. Identifying opportunities for improvement (technologies)
 - Scenario development
 - Eco-efficiency indicators
 - Technology assessment
4. Determining distributional issues (winners & losers)
5. Recommending guidelines & policies for technology uptake



The EcoWater Case Studies

- Agricultural water systems
 - Sinistra Ofanto, Italy
 - Monte Novo Irrigation Scheme, Portugal
- Urban water systems
 - Sofia, Bulgaria
 - Zurich, Switzerland
- Industrial water use sectors
 - Textiles - Biella, Italy
 - Energy - Netherlands
 - Dairy - Denmark
 - Automotive industry - Sweden



Expected final outcomes

- A. Better understanding of the factors that influence technology uptake & implementation in different sectors of water use
- B. Coherent, validated & tested methodological framework
 - Systemic environmental impact assessments
 - Economic assessments
 - Analysis of Value Chains & interactions among actors
- C. Integrated toolbox for systems' eco-efficiency analysis
- D. Policy recommendations for technology uptake & implementation
- E. Science-industry-policy links

EcoWater

Project Outreach

- Web Site and targeted dissemination material
 - <http://environ.chem.eng.ntua.gr/ecowater>
- Involvement of local actors in Case Study Development processes
 - Local Workshops
- Organization of large-scale targeted events, combined with international events to increase outreach
 1. **Research - Scientific Conference as AquaConSoil Side Event**
 2. Industry - Amsterdam AquaTech 2013
 3. Policy-makers - Brussels Green Week 2014
- Final Conference Event



EcoWater at the AquaConSoil event

- Present and (debate on) methodological context
 - Meso-level and its importance for analysing technology uptake dynamics
 - Indicators relevant to different levels/scales and case applications
- Demonstrate the usefulness of developed approaches and analytical tools
- Discuss findings for two EcoWater Case Studies on agricultural water use
 - Monte Novo, Alentejo, Portugal
 - Sinistra Ofanto, Italy



Conference Programme

- Session 1 - (Meso-level) Eco-efficiency: Concepts and Relevance
 - What are Eco-efficiency and the meso-level & what is their significance
- Session 2 - Meso-level eco-efficiency indicators: analysis, examples and calculation tools
 - How to measure eco-efficiency using indicators & computational tools
- Session 3 – Facilitating Wise Technology Decision Making: Technology Assessment, Scenarios and Stakeholders
 - How to support technology assessment and selection based on eco-efficiency
- Session 4 – Assessing Eco-efficiency of Technologies
 - Applied examples

Thank you for your participation and looking forward to our discussions!



Mainstreaming resource efficiency
UNEP Operational Strategy for Freshwater
(2012 – 2016)

EcoWater Scientific Event, AquaConsoil Conference
 Barcelona, 18 April, 2013

Maite Aldaya
 Consultant, UNEP

Shaoyi Li
 Head, Integrated Resource Management Unit, UNEP



Mainstreaming resource efficiency:

Promote water efficiency and demand management to ensure that governments, business and society around the world adopt and work towards targets using effective policy instruments, market incentives, innovative technology and reporting systems.

1. Awareness raising and capacity development;
2. Develop and improve methods and indicators to better measure water efficiency and develop a tool box with existing and emerging technologies and policy options;
3. Pilot activities, incentive frameworks and partnerships development and implementation.

Resource Efficiency defined...



Economic efficiency
 +
Environmental efficiency
 =
Resource efficiency
 (water, materials, energy, land & emissions)

Reducing the environmental impact of consumption and production of goods and services over their *full life cycles*

→ By producing more wellbeing with less resource consumption, RE enhances the means to meet human needs while respecting the ecological carrying capacity of the Earth.

Domestic: 10% Industrial: 20%

Irrigation: 70%

Environmental flows
 What's left

Nature's infrastructure provides services to people ("ecosystem services"), but environmental flows of water are needed if these services are to continue

Water-related services:

- Provision of fresh water for drinking, agriculture, electricity generating, etc.
- Regulation of floods and extreme weather events
- Purification of wastes
- Delivery of nutrient-rich sediments to flood plains

These are worth US\$7 trillion per year

Balancing water supply and demand

- Improve efficiency and productivity (40%)
- Investment in infrastructure, reform, technology (60%)

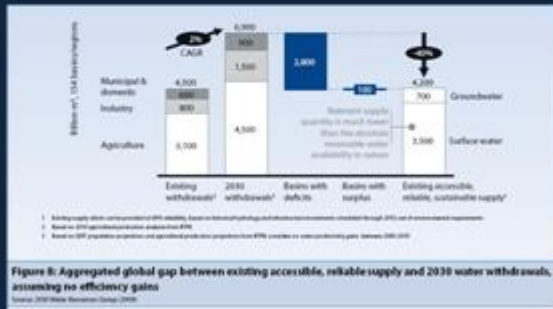

Did you know?

The world may suffer 40% fresh water deficit by 2030,

Fortunately many water problems are socio-economic and political, rather than physical, and could be solved by transparent and effective water governance.



"We can only manage what we measure"

Measuring water use in the economy and the environment is vital to meet global and local needs, both in developing and developed countries.



Water decoupling i.e. using less water and causing fewer environmental impacts per unit of economic output, **is possible and already happening in many regions and sectors**, offering win-win opportunities, especially in developing countries.

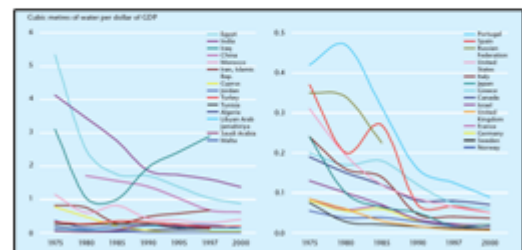

The ratio of water use to GDP in different countries (Source: UN-Water, 2005)

Efficient use of water

• Resource efficiency technologies

- Efficient irrigation techniques;
- leakage reduction;
- savings in urban water use (eco-design, urban planning);
- energy and water efficiency in supply and sanitation; reduction at source.

• Economic instruments

- Water pricing to provide incentives for innovation;
- full cost recovery (incl. environmental and resource costs);
- full transparency of water prices and investments;
- scrutiny on adverse subsidies.

• Cross-sectoral integration

- Water, agriculture, environment, energy, trade, transport, et al.

Decoupling requires finding the right balance between allocating water to human infrastructure and nature's infrastructure

Efficient water use



Industry

- Towards full water recycling in industries: zero blue water footprint
- Towards full recycling of materials and heat: zero grey water footprint



Agriculture

- Make rainwater more productive: lower green water footprint
- Towards supplementary or deficit irrigation & application of precision irrigation techniques: lower blue water footprint
- Towards organic farming: zero grey water footprint

Water and food security ... virtual water imports needs to be accounted for ...

National virtual water balances related to international trade of products

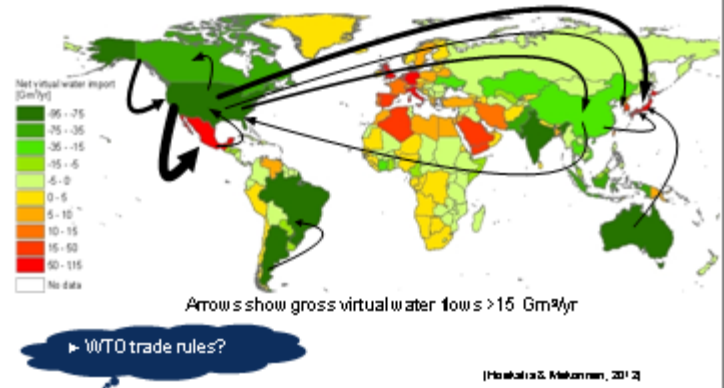

Challenges

1. Unwinding subsidies that keep prices artificially low and encourage inefficiency;
2. Ensuring that enough capital is available and that market failures associated with, for instance, property rights and incentives are corrected;
3. Bolstering society's resilience by creating safety nets to help very poor people deal with change and educating consumers and businesses to heed the reality of future resource constraints.

UNEP water efficiency activities and projects:

- UNEP International Resource Panel - Water Working Group
- Southeast Asia – KOICA - water accounting, footprint and efficiency - training and pilot projects.
- LAC – UNDESA - Strengthening Capabilities on Sustainable Resource Management - Water footprint training and pilot projects.
- Alliance for Water Stewardship – Board and International Standards Development Committee (ISDC).
- UN Water
- World Water Forum
- Others

For more information:

Maite Aldaya, PhD, consultant
Shaoyi Li, Head, Integrated Resource Management Unit

UNEP
Sustainable Consumption and Production Branch
Division of Technology, Industry and Economics
<http://www.unep.org>

Email: maite.aldaya@unep.org
shaoyi.li@unep.org





From Eco-innovation To System Innovation

Robbert Droop

- Netherlands' Ministry of Infrastructure and the Environment
- Eco-Innovaera

robbert.droop@minienm.nl

ECO-INNOVERA

Eco-Innovation is

(Ref. Eco-Innovation Action Plan – COM(2010)256)

- **any form** of innovation
- resulting in or aiming at **significant and demonstrable** progress ...
- towards the goal of sustainable development,
- through **reducing impacts** on the environment,
- **enhancing resilience** to environmental pressures,
- or achieving a more **efficient and responsible** use of **natural resources**.

- includes eco-industry and **other sectors**
- includes **incremental and radical** changes
- includes products/processes, **value-chains, and system changes**



Eco-industry turnover

Share of eco-industry turnover across the EU, 2008



Eco-innovation by EU industry

(Ref. Eurobarometer 2011)

- 75% of European businesses experience price increases
 - 50% of company's costs is material costs
 - 50% are innovators
- Among these 50% innovators:
- 45% reported that 10-30% of investments was for eco-innovation
 - 30% introduced new eco-innovative production methods
 - 25% introduced new eco-innovative products
 - 24% new organisational arrangements
 - Most of that in water, waste and agriculture





The eco-innovation gap



(ref. ED Report 2012)

Many European companies implement innovation, but the majority either still do not eco-innovate or the material savings achieved due to innovation are relatively low.

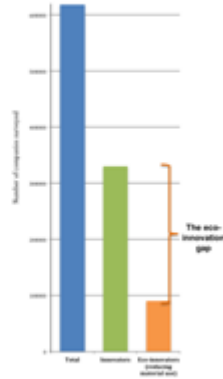

Source: ED 2012 (data from CA2012, www.eco-observatory.eu)



Yearly savings potential



Yearly savings potential – size-related perspective

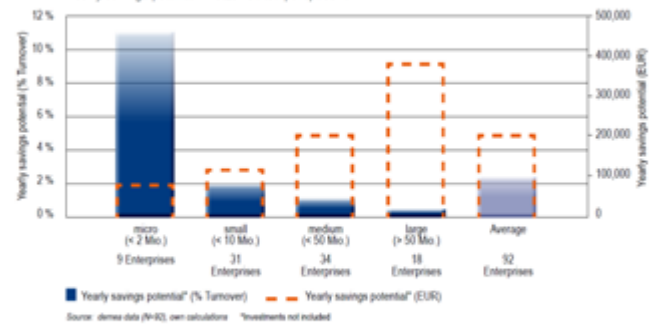

Source: edna data (N=42), own calculation. *Investments not included



Development of eco-innovation (1)

- Environmental Technologies
 - Emission-reduction (water, air, soil, landfill)
 - Impact-reduction (waste collection, recycling, recovery)

(ref. Environmental Technologies Action Plan ETAP – 2014)
- Eco-Efficiency
 - Energy and resources in production and consumption
 - Life cycle approach
 - Value-chain actions

(ref. Eco-Innovation Action Plan – 2011)



Stakeholders in the chain

Some experiences in Netherlands

- Business-cases:
- Jeans for Jeans (J4J)
 - Closing the gypsum chain
 - Food, Paper



Dutch Spirit



Chain action works ...

- > New business
- > New markets
- > New revenue streams

...with frontrunners.



Requires new entrepreneurship...

- Sector action - Building trust
 - Awareness - marketing approaches
 - Reporting and sharing of best practices
 - Training and capacity-building
 - Joint R&D - LCA
 - Unify certification schemes and standards
 - Including social values
 - Develop widely accepted label
 - Avoid "green washing"
- Chain action - Leverage partnerships
 - Clear benefits - shared objectives - LCA
 - Involve different affiliations - mutual trust
 - Joint / Coordinated R&D



...and new role from government.

- Long-term certainty
- Facilitate information and partnerships
- Share knowledge for product development
- Promote R&D for sustainable business
- Increase market acceptance
- Create space for development
- Government as launching customer



Research for eco-innovation

From Chain Management to Systemic Change

- Function-based
- Based on common vision
- Side-passing many lock-in
- Requires a new role for government and EU
- Leadership in Entrepreneurship and Patience

How to change the chain?



Development of eco-innovation (2)

- Environmental Technologies
 - Emission-reduction (water, air, soil, landfill)
 - Impact-reduction (waste collection, recycling, recovery)

(ref. Environmental Technologies Action Plan ETAP – 2014)
- Eco-Efficiency
 - Energy and resources in production and consumption
 - Life cycle approach
 - Value-chain activity

(ref. Eco-Innovation Action Plan – 2011)
- Systemic eco-innovation
 - Relation between human activity and ecosystem
 - Change of production and consumption patterns
 - Sustainable competitiveness by radical innovation and new markets

(ref. Eco-Innovation 2012)



Boosting eco-innovation through cooperation in research

ECO-INNOVERA

28 partners
15 countries + 3 regions
Organizations from research, environment, and economy



Boosting eco-innovation



COORDINATED BY PTJ

eco-innova.eu

LinkedIn



ASSOCIATED PARTNERS



ECO-INNOVERA

Boosting Eco-Innovation through Cooperation in Research

- Research on eco-innovation
 - Coordination of national research programmes
 - Joint trans-national funding
 - Strategy development
- Implementation of eco-innovation in Europe
 - Networking platform on eco-innovation
 - Dissemination: from research to markets



Eco-Innova suggests System Innovation

- Identified as an area of interest for the consortium
- A cross-cutting activity, distinctive from any other ERA-Net
- Topical subject among policy makers, businesses and researchers
- Potentially a means to achieve deeper levels of innovation faster





Character of System Innovation

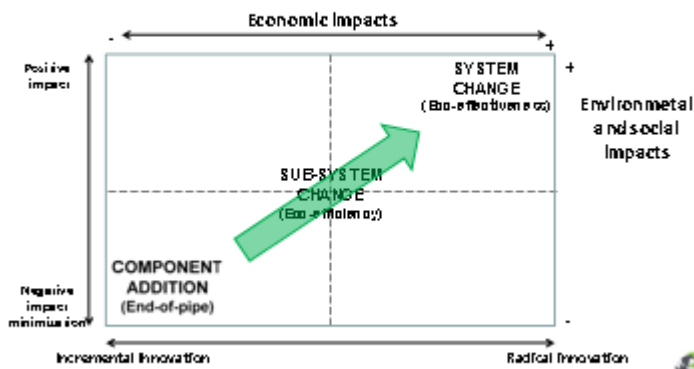

Co-Innovation matrix (based on Carlisle-Harmon et al, 2009)



Why Systemic Innovation?

- Increasing business critical issues, e.g. resource shortages, climate change impacts
- Companies need to engage beyond their borders, down their supply chains and support the wider system to change
- Often societal/cultural barriers
- Leading businesses face challenges too big and complex to tackle alone.
- Governments need collaboration with and support from business



Systemic Innovation

A set of interventions (new approaches or new applications that scale) that lead to a shift in a whole system (a sector, a city, an economy) on to a more sustainable or better ecological path.

- Having the key characteristics of being:
 - Interdisciplinary, multi-faceted: *combining behaviour, technology, policy and economy*
 - Radical, transformative: *creating significant change, using new approaches and applications*
 - Collaborative: *cross-sector, involving different players, new entrants, new types of partnerships*
 - Including whole value chains
 - Designed to work towards a shared eco or sustainability goal



Eco-Innova Calls – for – Tender 2012-2013

Systemic Innovation:

- Different models of production and consumption
- Major business opportunities for novel, transformative approaches to supplying goods and services

With focus on:

- New supply chains & substantial reconfiguration of existing supply chains
- Multiple innovations (mixtures of technological & socio-cultural innovation)
- Interdisciplinary and socio-economic contributions
- Radical disruption of the supply chain/business model

- Introduce SI approaches into future (trans-)national calls
- Suggest SI approaches for Horizon2020



Development of eco-innovation (3)

(Ref. FP7 and Horizon2020)

- WP 2007-2010 - environmental technologies
 - recycling, water, landfill, air, energy savings
- WP 2012 - eco-innovation
 - Highly innovative
 - Radical improvement of resource efficiency
 - Serves as an alternative
- WP 2013 - improving resource efficiency
 - Breakthrough solutions
 - Radical change
 - New business models, industrial symbiosis, C2C
- Horizon2020 - transition to green economy and society
 - Incremental and radical
 - Combining tech, organ, societal, business, policy
 - Business, symbiosis, PSS, product design, life cycle, C2C



System Innovation in the Water Sector



Salt marshes against flooding



Struvite scaling

Phosphate



- Building with Nature

- Recovery of valuable resources

- Retention of water surplus



Irrigated field



Energy



*Eco-Efficiency and Systemic Innovation
in the Water Sector*

Chain Management and System Innovation are opportunities

Challenges are large – to change is complex

Environmental and economic significance

The "market" is a driver for systemic innovation

Governments promote and facilitate

Strategy development in Eco-Innova

EU incorporates the concept



Boosting eco-innovation
through cooperation in research



Robbert Droop

robbert.droop@minienm.nl

Coordinator: e.echeverria@fz-julich.de



Meso-level eco-efficiency in Finland

Per Mickwitz, Research Director
Finnish Environment Institute (SYKE)

EcoWater Scientific Event:
"how to achieve more with less"
Barcelona, 18.4.2013



Structure of my presentation

- The world is not sustainable and we need to see this from a new perspective
- Why (also) the meso-level?
- How to approach meso-level eco-efficiency in a way that matters



The world is not sustainable

- Climate change
- Resource use
- Biodiversity
- Poverty ...

We need:

1. a better understanding of the interdependencies between consumption, production and the environment
2. new policies that would support and enable transformations of key consumption and production systems
3. political importance

The dominant framing of environmental problems, e.g. climate change

1.
PROBLEM



2. Global

3. Limit GHG emissions

1. Yes, 2. Yes, 3. Yes, BUT ...



But, but, but, ...

1. A need for a positive vision, of a low carbon and resource efficient future (Giddens 2009)



2. Emissions, mitigation, adaptation are also national and local > polycentric approach (Ostrom 2010, Hoffmann 2011)

3. Reducing GHG emissions will require that production and consumption systems are transformed

Policies on just the output (GHG emissions) not enough



The green economy concept could provide a (politically) new framing of sustainability, climate & environmental policy

From limits on emissions, waste, chemicals, growth, ...





The green economy concept could provide a (politically) new framing of sustainability, climate & environmental policy

From limits on emissions, waste, chemicals, growth, ...

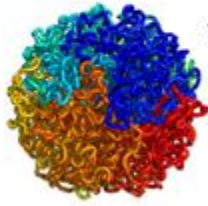

To a radical transformation of consumption and production systems (socio-technical)



Decoupling - water discharges from the Finnish pulp and paper production

From 1970 to 2002
Paper & board: + 215 %
BOD: - 97 %

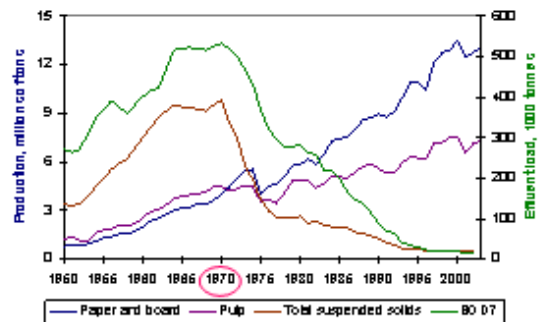

Finnish Forest Industries Federation & SYKE



Decoupling - water discharges from the Finnish pulp and paper production

From 1970 to 2002
Paper & board: + 215 %
BOD: - 97 %

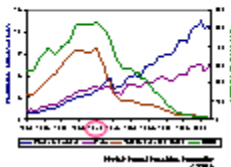

End-of-pipe technology & process technology
and
a better understanding of the
Ecosystem services
produced by water



Intervention model for environmental innovation
Expanded from Rennings' model of the determinants of eco-innovation (Kuitmaa 2007)

Kuitmaa P. 2007. The determinants of environmental innovations: The impacts of environmental policies on the Nordic pulp, paper and packaging industries. *European Environment*, 17(2): 92-105.



From technological innovations to system transformation, e.g. through industrial symbiosis

The importance of the regional level increases

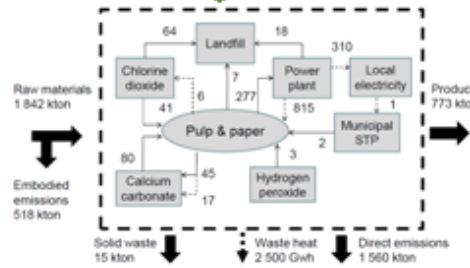

Malila, T., Pakarinen, S., & Sokka I. 2010. Quantifying the Total Environmental Impacts of an Industrial Symbiosis - a Comparison of Process-, Hybrid and Input-Output Life Cycle Assessment. *Environ. Sci. Technol.* 44(11): 4308-4314.



Conceptualising transitions

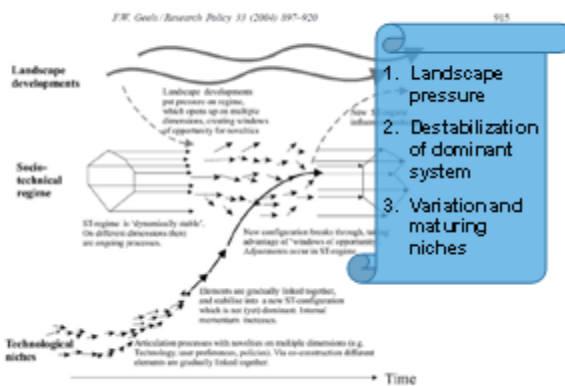
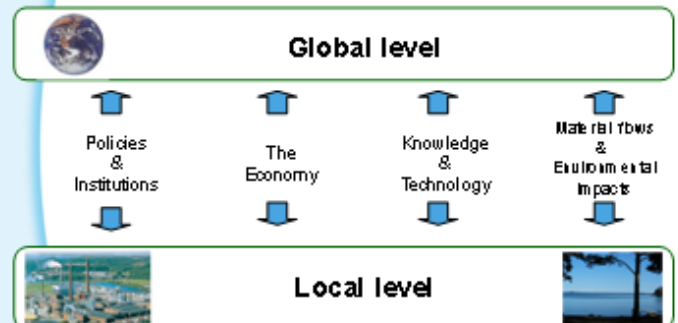

Fig. 9. A dynamic multi-level perspective on system innovations (Geels, 2002b, p. 110).



Complex multi-level connections



From a UN-centric to a polycentric Complex multi-level connections



SYKE

"The Eco-efficiency of Regions – Case Kymenlaakso (ECOREG)" 2002–2004



SYKE

"The Eco-efficiency of Regions – Case Kymenlaakso (ECOREG)" 2002–2004

The aim:

To demonstrate the concept and evaluation of eco-efficiency at a regional scale

The outcome:

Indicators for measuring regional eco-efficiency
 Concepts, approaches, working **processes**
A mechanism for applying the indicators

SYKE

The largest challenges of indicator (and other knowledge production)

- The "indicator industry" has created a huge number of projects producing indicators.
- **Usually they are neither updated nor used.**
- According to Rydin et al. (2003) this is because there is a **limited understanding**:
 - of the **local context** in which the indicators are developed
 - of the relationship between **experts and laymen**
 - of the **process** through which the indicators are developed.

SYKE

18

An example of the production strategy: The working process – based on multistakeholder involvement and empowerment

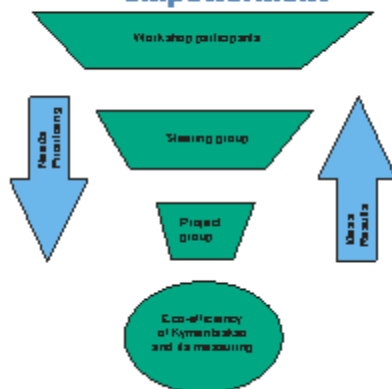

SYKE

The time span of the ECOREG project – the most important events



SYKE

Direct implications of the ECOREG project

The concept of eco-efficiency found its way to Kymenlaakso's Regional Strategic Plan 2005-2015

The *vision* for the future Kymenlaakso was formulated as: **"An attractive and eco-efficient, internationally interactive region"**

Eco-efficiency also has a central role in Kymenlaakso's **Regional Development Programme 2007-2010** that implements the Strategic Plan. Relevant **ECOREG indicators** are used for monitoring the Programme.

The *vision* in the Natural Resource strategy of Kymenlaakso from **2011**:

"Kymenlaakso is a frontrunner in the responsible, eco-efficient and innovative use of natural resources."



The ECOREG-project ended in 2004 – the indicators are still updated and used

A Southeast Finland Regional Environment Centre publication



- The first follow-up report 2005
- Expansion to South-Karelia 2006
- Annual reports, latest in 2012
 - 8 years after the project ended!
- The process continues: the regional steering group met 3 times in 2011.



20

Production, use and further development of the ECOREG indicators in Kymenlaakso, Phase 0, - 2002(9)

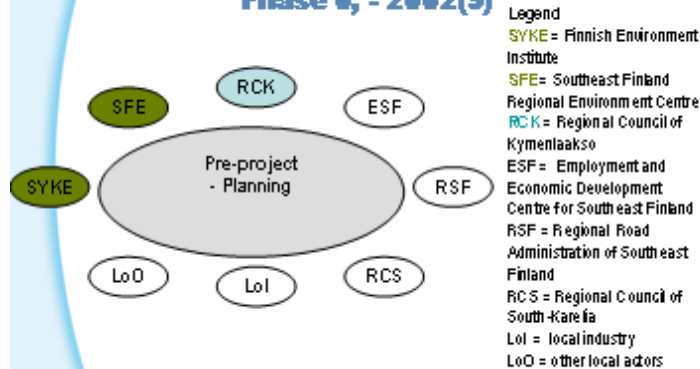

Production, use and further development of the ECOREG indicators in Kymenlaakso, Phase 1, 2002-4

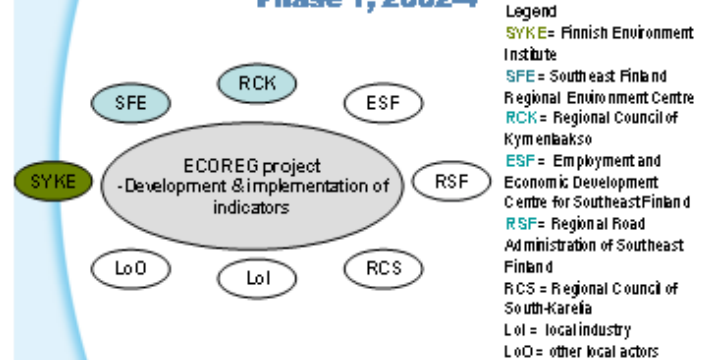

Production, use and further development of the ECOREG indicators in Kymenlaakso, Phase 2, 2005-6

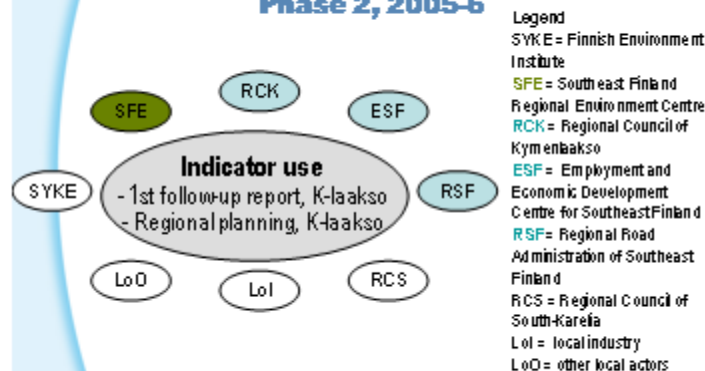

Production, use and further development of the ECOREG indicators in Kymenlaakso, Phase 3, 2006 -

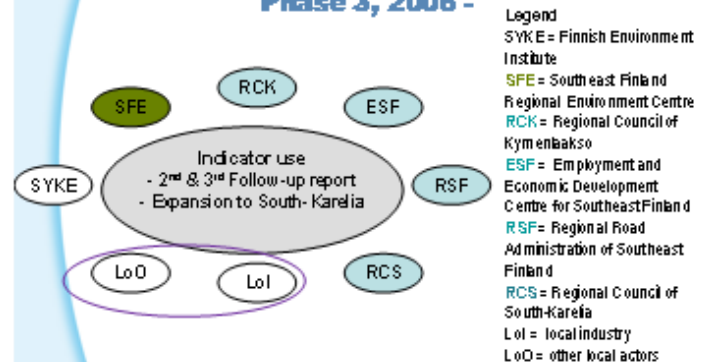

Why was co-operation successful in Kymenlaakso?

1. The **complementary strengths and capacities** of researchers and regional authorities – and other regional actors – were successfully combined:
 - the researchers contributed with theoretical and methodological expertise – which the local parties did not have.
 - the regional partners, for their part, brought the indispensable local knowledge to the work – this would definitely have been a weak point if the academia would have acted alone.
2. The **process was crucial** – especially the series of the **joint workshops** were instrumental in integrating the contributions of the different parties.
3. The **commitment of the two regional partners**, the Regional Council of Kymenlaakso and the Southeast Finland Regional Environment Centre, to the ECOREG work was real:
 - they foresaw the future opportunities
 - these organizations had visionary leaders with personal commitment



Some further reading

- Mickwitz P. and M. Melanen 2009. The Role of Co-operation between Academia and Policymakers for the Development and Use of Sustainability Indicators – A Case from the Finnish Kymenlaakso Region, *Journal of Cleaner Production*, 17(12) 1086-1100.
- Mickwitz P., M. Melanen, U. Rosenström and J. Seppälä 2006. Regional eco-efficiency indicators – a participatory approach, *Journal of Cleaner Production* 14(18), 1603-1611
- Rosenström U., P. Mickwitz and M. Melanen 2006. Participation and Empowerment-based Development of Socio-cultural Indicators Supporting Regional Decision-Making for Eco-efficiency, *Local Environment*, 11(2), 183-200.
- Mickwitz, P., (2012). The Road to Rio+20: An Opportunity Missed(?), *Forum for Development Studies*, 39:1, 75-81
- Mickwitz, P., M. Hildén, J. Seppälä and M. Melanen, (2011). 'Sustainability through system transformation: Lessons from Finnish efforts', *Journal of Cleaner Production*, 19 (16) 1779–1787.



23

The Meso-level in the EcoWater Project



Christoph Hugi

EcoWater n|w University of Applied Sciences Northwestern Switzerland School of Life Sciences

Content

- Why meso-level?
- Definition of meso-level
- Meso-level technology uptake assessment
- Conclusion and outlook

EcoWater n|w University of Applied Sciences Northwestern Switzerland School of Life Sciences

2

Why Meso-Level? I

Economic and environmental challenges are growing and ...

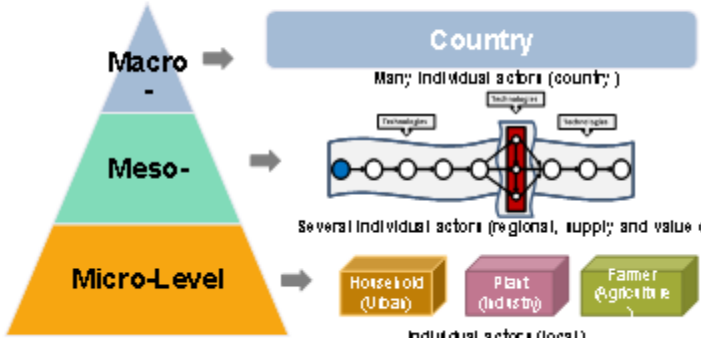

... are often regional, involving several actors.

EcoWater n|w University of Applied Sciences Northwestern Switzerland School of Life Sciences

3

Increasing Eco-efficiency (EE)

Increasing wealth while ...



...reducing environmental impact requires eco-innovation.

Source: <http://www.wuppertal.de/>
EcoWater n|w University of Applied Sciences Northwestern Switzerland School of Life Sciences

4

Eco-Efficiency Indicator Definition

Compare the Eco-efficiency with ...

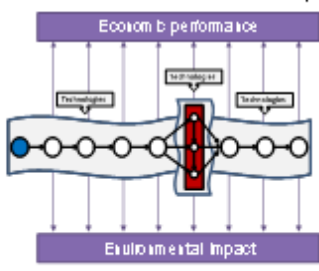
$$\text{Eco-Efficiency Indicator} = \frac{\text{Economic Performance Indicator (EPI)}}{\text{Environmental Impact Indicator (EII)}}$$

...and without implementation of innovative technologies.

EcoWater n|w University of Applied Sciences Northwestern Switzerland School of Life Sciences

5

Eco-Innovation Uptake

Sub-optimal results due to micro/macro-level decision making...

| Technology-Scenario | Actor 1: water supply | Actor 2: water user | Actor 3: water user disposal | Eco-efficiency of total value chain | Results for policy recommendation |
|------------------------------------|-----------------------|---------------------|------------------------------|-------------------------------------|--|
| Water saving appliances at actor 2 | EPI - EII + | EPI + EII + | EPI - EII + | Increase | Meso-level problem: Actor 2 will implement the measure |
| Water treatment at actor 2 | EPI - EII + | EPI - EII + | EPI + EII + | Increase | Meso-level problem: compensation of A1, A2 required |

Positive/ Negative development of indicators from actor's view

... and tendency to expensive end of pipe solutions.

EcoWater n|w University of Applied Sciences Northwestern Switzerland School of Life Sciences

6

Why Meso-Level? II

Micro- and macro-level decisions are often suboptimal ...

- Micro: individual actors' decision making is not appropriate to minimize environmental impacts of most systems (especially for external costs)
- Macro: tendency to regulation driven, marginal and inefficient end of pipe solutions

→ uptake of eco-innovative solutions is not fostered ... for overall efficient innovations.

Meso-level eco-efficiency analysis

- The meso-level is a ...
 - Resource supply chain
 - Product/service system (value chain)
 - Region
 - Sector

(Technopolis Group, 2009)
- Meso-level analysis features:
 - Interdependencies among system elements – Whole different than the sum of its parts
 - Heterogeneity among actors
 - Whole life-cycle perspective
- Promising technology innovations in a specific system can change the landscape (macro-level)
 - Re-configuration - adaptation
 - Re-orientation through policy

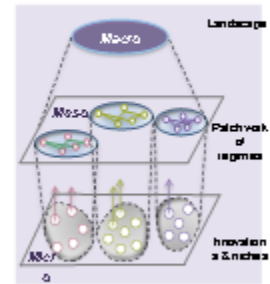

Adapted from: Galis, F.V., 2002, Technological transitions: a multi-level perspective and a case-study. Research Policy 31 (8-9), 1231-1244.

Meso-level dimensions & dynamics in EcoWater

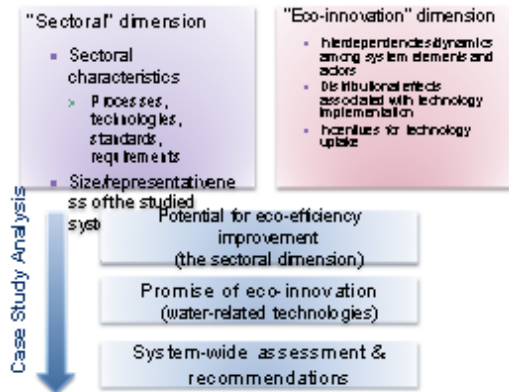

EcoWater Technology Uptake Assessment

- I. Analysis of the physical system
 - System boundaries
 - Water supply chain mapping
 - Value chain mapping
 - Preliminary list of measures to improve the system
- II. Baseline eco-efficiency assessment
 - Estimation of the eco-efficiency indicators
 - Economic Performance
 - Environmental Impact
 - Interpretation of baseline eco-efficiency assessment results
- III. Technology Assessment
 - Identification of Technologies
 - Eco-Efficiency Assessment with new technology
 - Interpretation of baseline eco-efficiency assessment results

Conclusions and Outlook

Conclusions:

- Micro/macro decision levels create barriers for eco-innovation
- Meso-level assessments help optimize systems and could foster uptake of eco-innovation
- Approach and tools have been developed for the water sector

Outlook:

- Calculation of the eco-efficiency indicators for the assessment of water technologies
- Aggregation of different environmental impacts as in a life cycle assessment
- Tool of implementation for the Meso-Level concept:

Thank you for your attention!

EcoWater

Annex D: SESSION 2: MESO-LEVEL ECO-EFFICIENCY INDICATORS: ANALYSIS, EXAMPLES AND CALCULATION TOOLS

*Presentation: Environmental Indicators to measure and monitor impacts of innovation on the macro-scale.
By Tomas Rydberg, IVL Swedish Environmental Research Institute, Sweden.*



Environmental indicators to measure and monitor impacts of innovation on the macro-scale

Tomas Rydberg, IVL



7th Framework Programme
Theme 6: Environment



Indicators to measure and monitor environmental impacts (on the macro-scale) of innovation (on any scale)



7th Framework Programme
Theme 6: Environment



ENVIRONMENTAL MACRO INDICATORS OF INNOVATION

Presentation outline

- About EMInn
- Innovation & assessment from micro to macro
- Indicators
- Indirect effects
- Wrap-up



ENVIRONMENTAL MACRO INDICATORS OF INNOVATION

About EMInn



7th Framework Programme
Theme 6: Environment

Who am I ?



- Senior Consultant & Project Manager
- Background: Chemical Engineering
- Ph. D., Environmental Science (1994)
- Eco-performance of products/technology systems, e.g. LCA, EEA, CBA
- Previously: Volvo Technology, European Commission - JRC, Consultant (CIT)

What is IVL ?

- "Joint Venture" Government/Industry
- Consultancy as well as Scientific Research to promote sustainable development
- Staff Count: = 200
- Stockholm, Gøteborg, Beijing, ...
- Thematic areas
 - Products / Waste
 - Bulk Environment
 - Sustainable Production
 - Climate / Energy
 - Air pollution/Transport
 - Water mgmt/pollution



IVL Swedish Environmental Research Institute

ENVIRONMENTAL MACRO INDICATORS OF INNOVATION

What is EMIInn

FPT Research project

- 01/11/2011 - 31/05/2015
- Total Budget: 3.2 Mio €

Objectives

- Accurate and comprehensive information on the environmental impacts of innovation
- Strengthening the science-policy link
- Reinforced ability to monitor the environmental impact of eco-innovation at the macro-level

What we do

- Ex-post assessment of the economy-wide environmental impacts of selected pervasive innovations through the application of advanced analytical frameworks

ENVIRONMENTAL MACRO INDICATORS OF INNOVATION

Partners



Wuppertal Institute
for Climate, Environment and Energy



UCL



CML
Institute of Environmental Sciences



TNO innovation for life



IVL Swedish Environmental Research Institute



Maastricht University
UNU-MERIT



CERIS
ISTITUTO DI RICERCA SULL'IMPRESA E LO SVILUPPO

21 April 2013

ENVIRONMENTAL MACRO INDICATORS OF INNOVATION

EMIInn Case studies

- Technologies of energy supply and demand – desulphurization plants
- Transport – diesel engines in cars
- Information and Communication Technologies (ICT) – The internet
- Built environment and buildings – energy saving technology
- Waste management and recycling – landfill phase-out

Work Plan

You are here

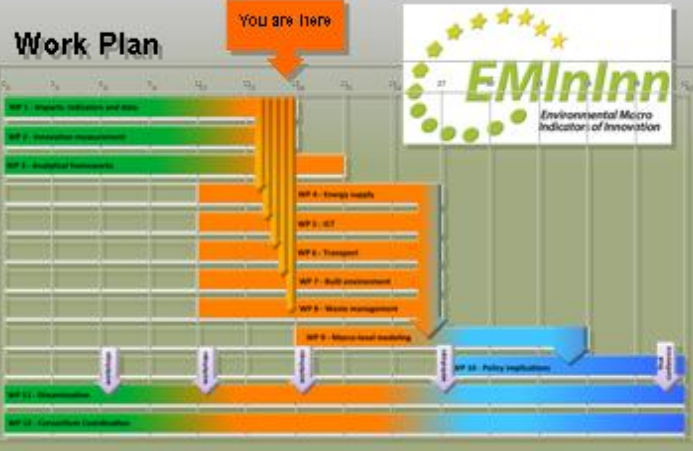

EMIInn
Environmental Macro Indicators of Innovation

23 April 2013

ENVIRONMENTAL MACRO INDICATORS OF INNOVATION

Innovation and assessment from micro to macro



7th Framework Programme, Theme 6: Environment

Example of macro level environmental indicator: CO₂ emissions (Gg) from public electricity and heat production between 1990 and 2010, Sweden.

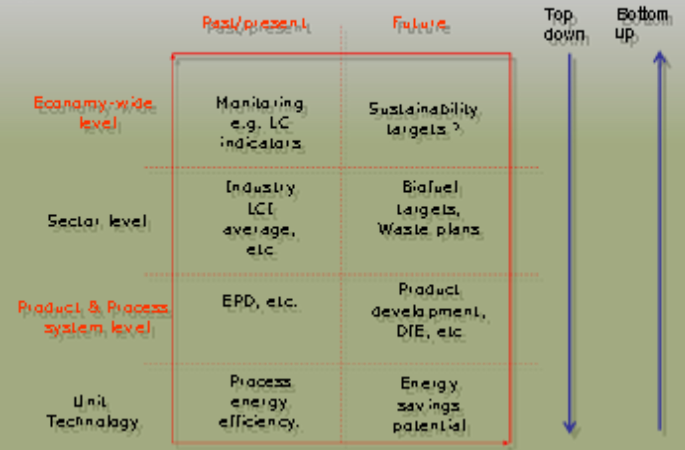
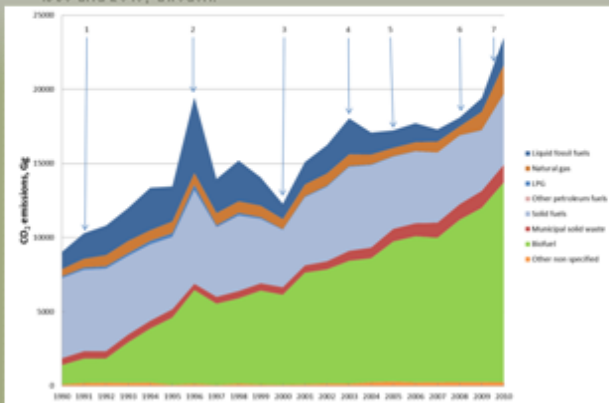

Indicators



Proposals (EMInInn) Environmental Indicators

1. Use existing indicators
2. Use only Pressure indicators
3. Obtain macro-level indicators from databases
 - that have time series
 - that cover the relevant geographical area
 - that are comprehensive
 - that have sufficient detail
 - if possible, that are "EU-approved"
4. Obtain micro-level indicators from (case study specific) databases
 - that are relevant
 - that are comprehensive
 - if possible, that are "EU-approved"

Existing indicators

Use existing indicators:

- many many environmental indicators around
- no need to define additional ones

EMInInn environmental indicators in relation to the DPSIR framework

Use only Pressure indicators:

- Indicators exist along the DPSIR chain
- P the most relevant place in the chain
 - can be linked to economic activities
 - and to environmental impacts
- Pressure: in LCA terms "environmental interventions"
 - emissions
 - extractions
 - land use
- Aggregating pressure indicators as in LCIA: optional.

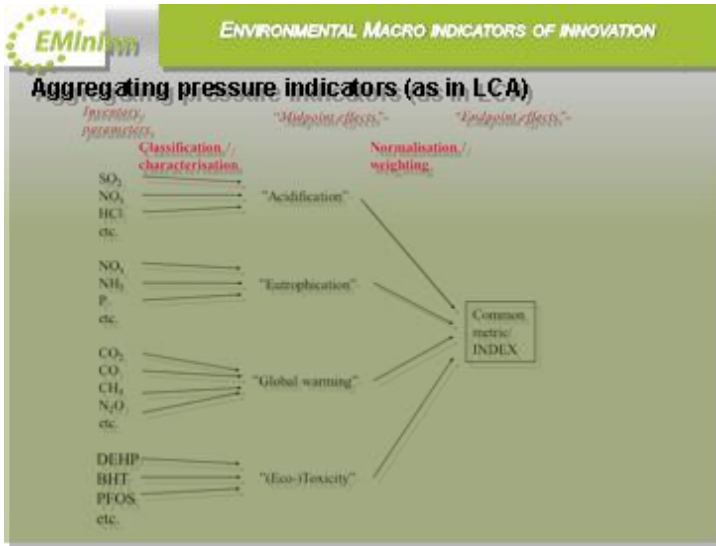

EMInn ENVIRONMENTAL MACRO INDICATORS OF INNOVATION

LCA indicators (midpoint)

(typically physico-chemical aggregation of "pressure indicators")

| Impact category |
|---|
| Climate Change |
| Ozone Depletion |
| Ecotoxicity - aquatic, freshwater |
| Human Toxicity - cancer effects |
| Human Toxicity - non-cancer effects |
| Particulate Matter/Respiratory Inorganics |
| Ionising Radiation - human health effects |
| Photochemical Ozone Formation |
| Acidification |
| Eutrophication - terrestrial |
| Eutrophication - aquatic |
| Resource Depletion - water |
| Resource Depletion - mineral, fossil |
| Land Transformation |

EMInn ENVIRONMENTAL MACRO INDICATORS OF INNOVATION

Indirect effects



7th Framework Programme
Theme 6: Environment

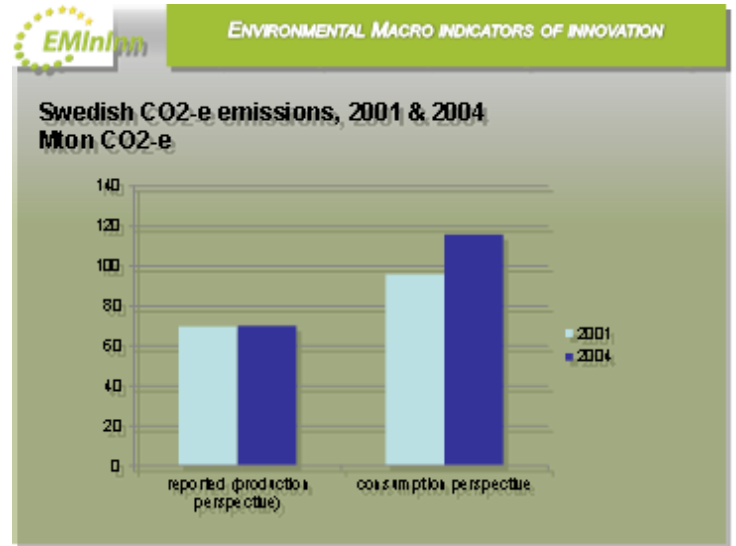

EMInn ENVIRONMENTAL MACRO INDICATORS OF INNOVATION

Wrap-up



7th Framework Programme
Theme 6: Environment

- EMInn** ENVIRONMENTAL MACRO INDICATORS OF INNOVATION
- ### Wrap-up = Key interim messages
- Use a combination of Top-down and Bottom up approaches for the analysis
 - Use existing indicators, no need to invent new ones
 - Pressure indicators (also aggregated)
 - Indirect/Rebound effects are difficult but very important for the outcome
 - Watch out for burden-shifting



Thanks!



tomas.norberg@vl.se

For further information
please visit our website:

www.eminn.eu

Presentation: *The EcoWater analytical approach for (meso –level) indicator development and technology assessment. By Michiel Blind, Deltares, The Netherlands.*



The EcoWater analytical approach for (meso–level) indicator development and technology assessment

Michiel Blind, Deltares, The Netherlands







Content

- Case study roadmaps
- Ecoefficiency definition (revisited)
- Impact Indicator development
 - Selection of indicators
 - Selection of parameters
- Technology assessment
- Conclusions

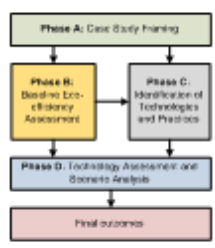

Case study framework – main steps



Case study roadmaps

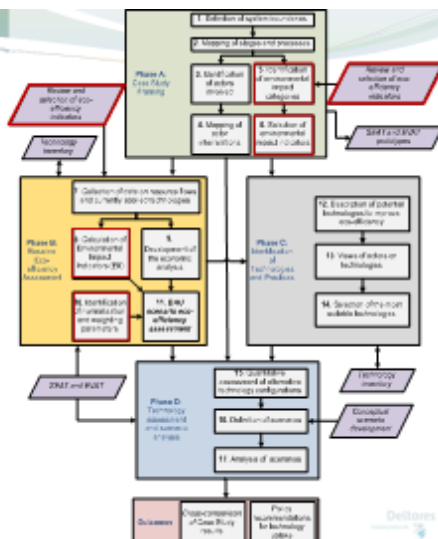

This presentation

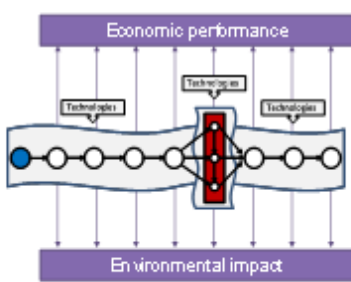

Eco-Efficiency Indicator Definition

$$\text{Eco-Efficiency Indicator} = \frac{\text{Economic Performance Indicator}}{\text{Environmental Impact Indicator}}$$



Economic performance indicator

$$\text{TVA} = \text{EVU} + \text{INC} + \text{TFC}$$

- **T**otal **V**alue **A**dded
- **E**conomic **V**alue of **U**se (income generated by using water)
- **I**NCome generated from by products
- **T**otal **F**inancial **C**ost of (pre-)treatment and transport of water

Criteria for selecting Environmental impact indicators

- Relevance for the different stakeholders
 - support to management decisions and actions
 - sufficient communication capability
- Data availability at the appropriate scale and in consistent (standard) units (e.g. kg, m3, EUR).
- Sensitivity to change over time / to alternative future scenarios

Environmental Impact Indicators

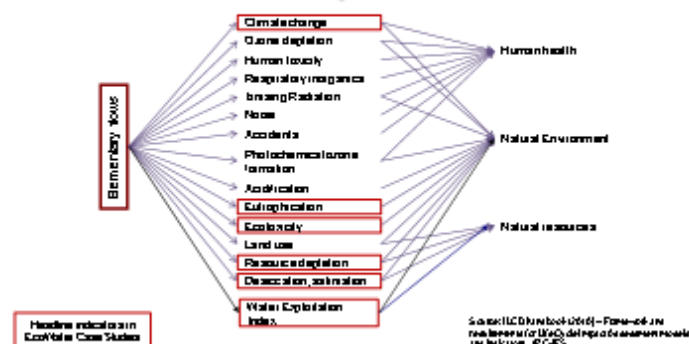

Source: ICD Handbook (2016) – Formed in the context of the ECoWater Case Studies

(Aquatic) Eutrophication potential

| Substance | gPO_{4eq}^{3-} / g |
|-------------|----------------------|
| PO_4^{3-} | 1.00 |
| H_2PO_4 | 0.97 |
| P | 3.06 |
| NO_3 | 0.13 |
| NO_2 | 0.13 |
| NH_3 | 0.35 |
| NH_4^+ | 0.33 |
| NO_2^- | 0.10 |
| HNO_3 | 0.10 |
| N | 0.42 |
| COD | 0.022 |

- One can use a subset of the parameters, depending on the local situation
 - From 'generic potential' to 'local eutrophication potential'.

Climate Change: Global warming potential

Table 10.2. Global warming potential (GWP) relative to CO₂ (Table 2.1.2)

| Substance | Chemical Formula | Global Warming Potential (GWP) | Global Warming Potential for 100-year time horizon | | | |
|----------------|------------------|--------------------------------|--|-----------------|------------------|-------|
| | | | CO ₂ | CH ₄ | N ₂ O | Other |
| Carbon dioxide | CO ₂ | 1 | 1 | 1 | 1 | |
| Methane | CH ₄ | 25 | 25 | 25 | 25 | |
| Nitrous oxide | N ₂ O | 298 | 298 | 298 | 298 | |

Table 10.3. Global warming potential (GWP) relative to CO₂ (Table 2.1.2)

| Substance | Chemical Formula | Global Warming Potential (GWP) | Global Warming Potential for 100-year time horizon | | | |
|----------------|------------------|--------------------------------|--|-----------------|------------------|-------|
| | | | CO ₂ | CH ₄ | N ₂ O | Other |
| Carbon dioxide | CO ₂ | 1 | 1 | 1 | 1 | |
| Methane | CH ₄ | 25 | 25 | 25 | 25 | |
| Nitrous oxide | N ₂ O | 298 | 298 | 298 | 298 | |

Local specificities - Electricity

- Meso-level: include Electricity in Global Warming Potential

| Country (EU/EEA) | CO ₂ Emissions (kg/kWh) | Rank |
|------------------|------------------------------------|------|
| Denmark | 0.000127 | 7 |
| Belgium | 0.000250 | 8 |
| Denmark | 0.000127 | 10 |
| Finland | 0.000259 | 9 |
| France | 0.000094 | 6 |
| Germany | 0.000098 | 16 |
| Greece | 0.000091 | 22 |
| Ireland | 0.000099 | 19 |
| Italy | 0.000175 | 12 |
| Luxembourg | 0 | 1 |
| Netherlands | 0.000094 | 17 |
| Portugal | 0.000097 | 15 |
| Spain | 0.000171 | 11 |
| Sweden | 0.000095 | 5 |
| United Kingdom | 0.000130 | 13 |
| Czech Republic | 0.000088 | 21 |
| Hungary | 0.000165 | 20 |
| Latvia | 0.000080 | 4 |
| Norway | 0.000062 | 2 |
| Poland | 0.000162 | 23 |
| Slovak Republic | 0.000172 | 10 |
| Slovenia | 0.000062 | 2 |
| Turkey | 0.000087 | 14 |

Table source: A Manual for the Preparation and Use of Eco-Energy Indicators, Version 1.1, United Nations, New York and Geneva, 2004

Water Exploitation Index (debated indicator within EcoWater)

- Annual total abstraction of fresh water divided by the long term annual average renewable resource.
- Acceptable EEA method, requires regionalization (to basin level)
- Warning level: 20%

Figure 1: Water exploitation index (%) across Europe

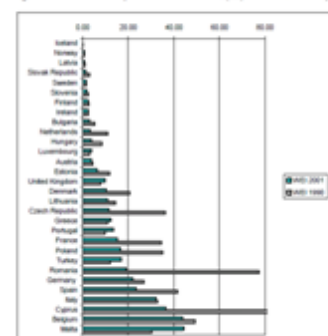

Resource depletion (ultimate reserve based)

- Production/(Ultimate Reserve)², compared to Antimony (alternatives methods are available)

| | Hydroaborg (t) | Rank |
|-------------------|----------------|------|
| antimony (Sb) | 1 | 11 |
| chlorine (Cl) | 2,7135E+06 | 6 |
| chromium (Cr) | 6,6664E+06 | 9 |
| cobalt (Co) | 1,5482E+06 | 5 |
| copper (Cu) | 6,6616E+07 | 10 |
| gold (Au) | 5,0242E+17 | 13 |
| iron (Fe) | 5,2471E+08 | 2 |
| lithium (lithium) | 1,5076E+08 | 1 |
| silver (Ag) | 1,1966E+06 | 4 |
| nickel (Ni) | 6,5291E+06 | 7 |
| platinum (Pt) | 1,1819E+08 | 12 |
| zinc (Zn) | 6,6666E+07 | 8 |
| zirconium (Zr) | 5,4444E+06 | 3 |

'Open' Indicators

- Energy used
- Fertilizer used
- Pesticides used
- Total amount of chemicals used
- Sludge produced
-

Technology assessment



For **Business As Usual (BAU)** and for **each technology**

- For each step in the value chain
 - Calculate the Total Value Added (=TVA = EVU - HNC)
 - Calculate the indicators (based on underlying parameters)
- Sum across
- Divide Technology results by BAU

Eco-efficiency: relative to BAU

(higher values, higher efficiency)

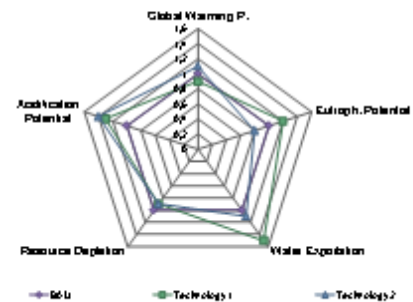

Eco-efficiency index?

- Index = \sum (indicators)
- Index = $\sum f(\text{Global Warming, Eutrophication, Resource Depletion, ...})$
- Options for "f":
 - Political goals
 - Sustainability goals
 - Individual preference
 - Valuation
 -
- EcoWater conclusion:
 - Index calculation is very tricky
 - Added value is limited – proceed (if required) case by case

Conclusions

- A stepwise approach to develop case studies has been designed
 - Indicators play a significant role in various steps
 - Testing an adaptation is on the way
- A view on selecting and using impact indicators has been developed.
 - We decided to stay close to 'proven indicators'
 - We decided to use only subsets of underlying parameters – based on relevance
- We decided not to work towards an index

Presentation: *Meso-level indicators in the Monte Novo Irrigation Scheme, Southern Portugal. By Rodrigo Maia, Universidade do Porto Faculdade de Engenharia, Portugal.*

Meso-level indicators in the Monte Novo Irrigation Scheme, Southern Portugal

Rodrigo Maia

AquaConSoll Conference Side Event
Barcelona, 18 April 2013

Ecoefficiency in agriculture

- The production of irrigated crops involves the use of water to increase productivity.
- Being a production factor, there is an economic added value associated to water use for irrigation.
- On the other hand, water use implies also considerable environmental impacts.
- Ecoefficiency assessment in agriculture, for a certain area, regards the comparison of the economic added value due to the production of irrigated crops, with the environmental impacts caused during that process.

Economic performance indicator

- In agriculture, the total value added (TVA) can be derived from the total value of the products

$TVA = EVU - TFC_{WS}$

$EVU = TVP - EVP_{WS}$

- TVA: total Value Added
- EVU: total Economic Value from water use
- TFC_{WS} : Total Financial Costs related to Water Supply
- TVP: Total Value of the Products
- EVP_{WS} : Expenses used for all non-water inputs

Environmental impact indicator

For agricultural sector:

- Total energy use [kWh]
- Surface Water use [m^3]
- Groundwater use [m^3]
- Total fertilizers (N, P) use [kg]
- Total CO₂ emissions [tons]
- Total N, P loads [kg]

e.g. $\frac{\text{Total Energy Used}}{\text{Water Used}}$ in kWh/ m^3

Meso level definition for agriculture

- Includes the different stages of Irrigation water systems and use:
 - water abstraction and sources
 - division, conveyance, storage
 - distribution to end-users (farmers),
 - water use in cropped fields,
 - subsequent downstream stages such as drainage, collection, treatment, and disposal of run-off and drained water to final receptors.
- The main categories of environmental impacts and concerns generated by irrigated agriculture along the referred chain must also be identified, as well as the main actors involved at different stages, together with their roles and interactions.
- Focusing on technology uptake, the eco-efficiency assessment shall regard the conditions of business-as-usual and future evolution scenarios for different technologies.

EcoWater agricultural Case Studies



CS #2 – Monte Novo CS #1 – Sinis tra-Olivença

EcoWater agricultural Case Studies

General characteristics



| | CS 1 - Sinis tra-Olivença | CS 2 - Monte Novo |
|-------------------------|--|--|
| Surface area (ha) | 5000 | 7000 |
| Age of system | Old, established > 200 | New (2010), water development |
| Crops | low water demanding (olives, wheat, vineyards, orchards) | high water demanding (maize, rice, vegetables, sugarcane) |
| PK (m ³ /ha) | Olives 1300, wheat 1000, vineyards 2500, orchards 4500 | Maize 9000, olives 1300-2000, sugarcane 10000, vegetables ¹ |
| Water availability | limited | Abundant, limited |

Example of Monte Novo Case Study

The main objectives set up for the Portuguese Case Study are:

- To assess the overall performance of a relatively recent hydro-agricultural system, and
- To assess the impacts of the introduction of new conditions (change of crop, technology, management strategies, policies, competitive uses and economic systems) on its eco-efficiency.

The assessment will be based on a set of indicators describing the eco-efficiency of the system in terms of irrigation water management and use, water productivity and income from agricultural production, and the minimization of the impacts on the environment (water, soil and air).

The Case Study will further assess new technologies and management strategies for irrigation water use and agricultural development.

Example of Monte Novo Case Study

Monte Novo Irrigation Area – geographical location



The Portuguese Case Study is being implemented in the Monte Novo Irrigation Scheme, covering an area of 7700 ha in two municipalities (Évora and Portel) of the Alentejo region (southern Portugal).

Example of Monte Novo Case Study

Souroe: EDIA

Monte Novo Irrigation Area – part of Alqueva project

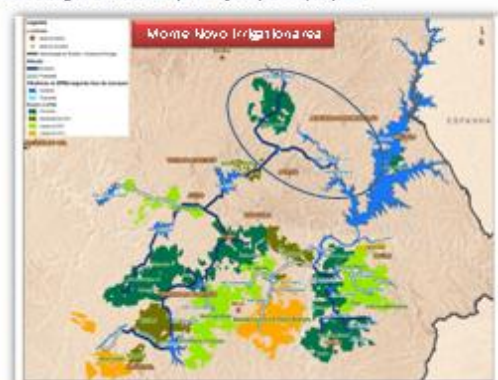

Example of Monte Novo Case Study

Source: EDIA

Monte Novo Irrigation Area - Analysis of Water supply system characteristics

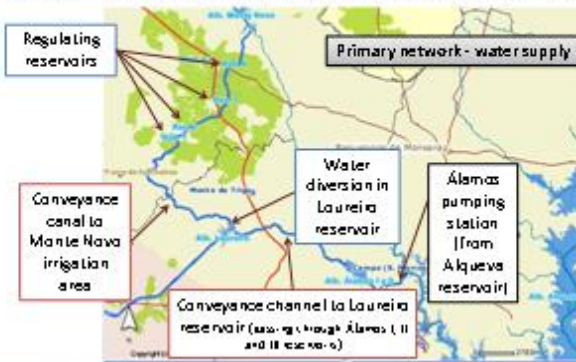

Example of Monte Novo Case Study

Source: EDIA

Monte Novo Irrigation Area - Analysis of Water supply system characteristics

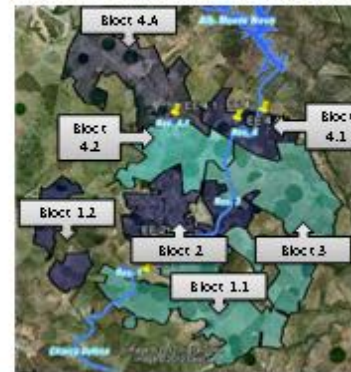

Legend:

- High pressure levels (4 bar) - enabling farmers to use water directly from distribution network, without any additional pumping station (higher water tariffs).
- Low pressure levels (1 bar) - implying that farmers have to install their own pumping stations to ensure the levels of pressure head required (lower water tariffs).

Example of Monte Novo Case Study

Source: EDIA

Monte Novo Irrigation Area - Main characteristics of the irrigated area

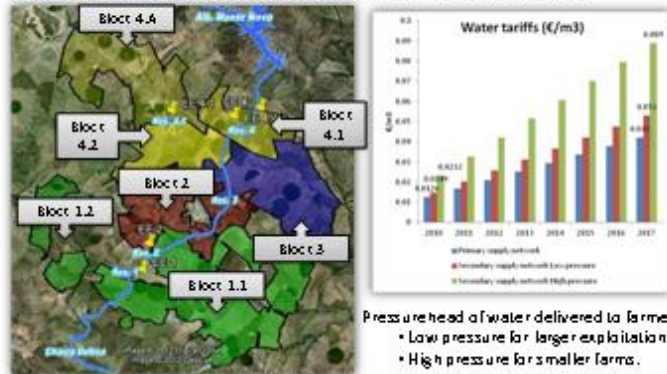

Pressure head of water delivered to farmers:

- Low pressure for larger exploitations.
- High pressure for smaller farms.

Example of Monte Novo Case Study

Source: EDIA

Monte Novo Irrigation Area - Main characteristics of the irrigated area

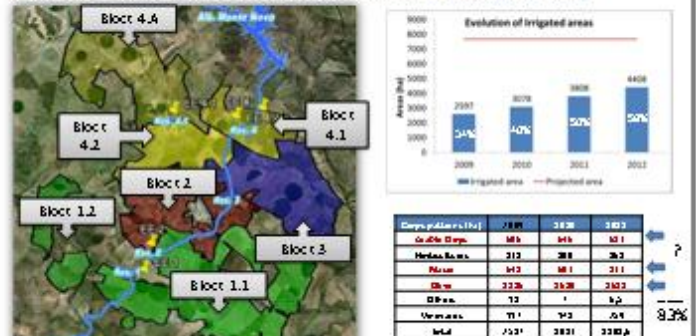

Meso level Indicators

- The EcoWater eco-efficiency indicators should flexibly encompass meso-level interactions which influence the adoption and effects of micro-level changes.
- This assessment will consider both an economic component and an environmental component.
- The economic component refers to the financial costs related to water abstraction, storage, conveyance, distribution and use, and to the economic value generated by the irrigated agriculture.
- The environmental component takes into account the impacts resulting from the sectoral water use on the main natural resources and receptors.

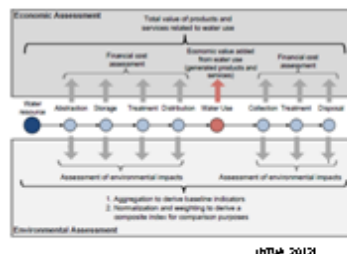

Example of Monte Novo Case Study

Monte Novo Irrigation Area - Meso-level value chain

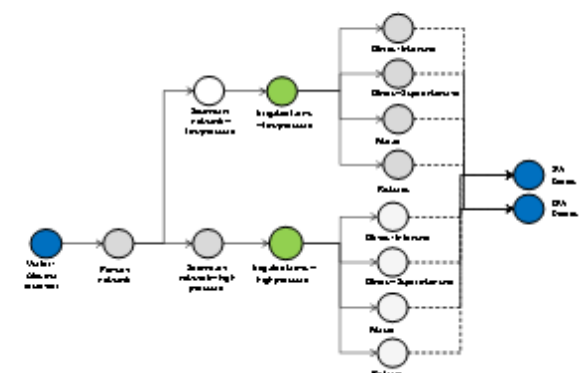

Example of Monte Novo Case Study

Monte Novo Irrigation Area – Meso-level indicators

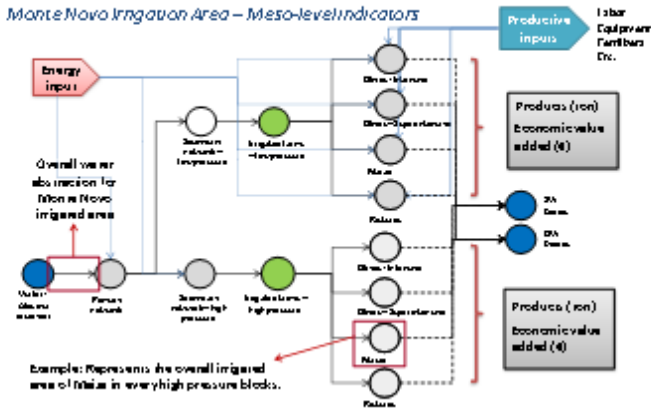

Example of Monte Novo Case Study

Monte Novo Irrigation Area – Meso-level indicators

Application of ecoefficiency indicators to the overall results

| | |
|-----------------------------|---|
| Value added per... €/... | <ul style="list-style-type: none"> Total energy use [kWh] Surface Water use [m³] Total fertilizers [N, P] use [kg] Global warming potential/CO₂ emissions [tons] Eutrophication potential/ Total N, P loads [kg] |
|-----------------------------|---|

Meso-level representation will be ensured through the quantification of the total added value of the area (for all crops, both on high and low pressure areas) and for the sum, along the value chain, of: energy use, water consumption, fertilizers consumption, CO₂ emissions, etc.

Example of Monte Novo Case Study

Monte Novo Irrigation Area – Meso-level indicators

Ecoefficiency indicators – preliminary results

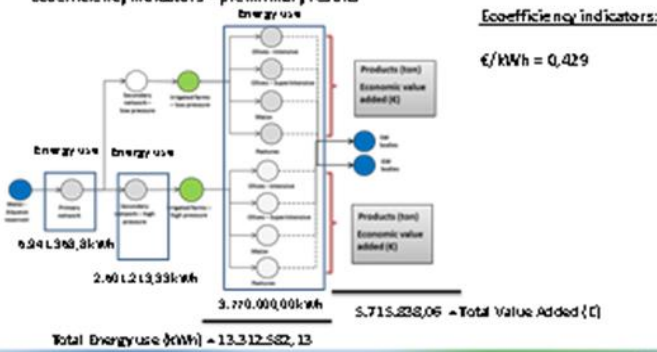

Example of Monte Novo Case Study

Monte Novo Irrigation Area – Meso-level indicators

Ecoefficiency indicators – preliminary results

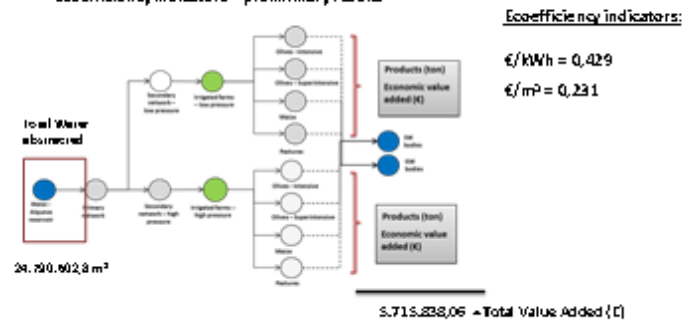

Example of Monte Novo Case Study

Monte Novo Irrigation Area – Meso-level indicators

Ecoefficiency indicators – preliminary results

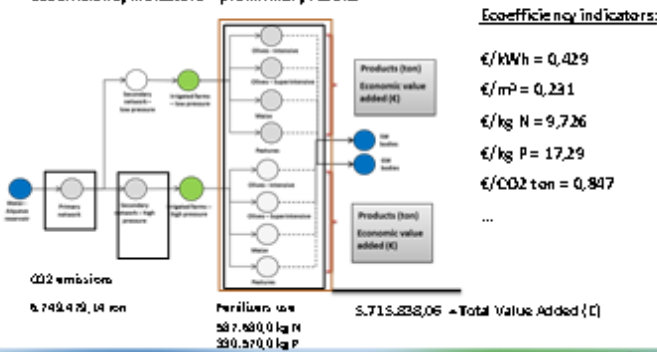

Technologies (and Management Practices)

- The objective is to assess technologies and management practices that would result in enhancing eco-efficiency of water use in agricultural systems in the future, with respect to the baseline scenario.
- The eco-efficiency improvements related to technological innovations of agricultural systems supply chain may result from:
 - The higher economic value being generated by irrigated agriculture in the area.
 - The lower financial costs at different stages of the irrigation system to sustain the agricultural production levels.
 - The reduced environmental impacts being generated as a result of intensive farming under irrigation.

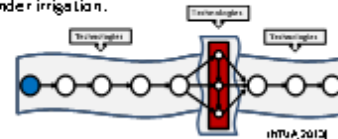

Example of Monte Novo Case Study

Monte Novo Irrigation Area – Technologies and Management Practices to be assessed

Water supply chain/ delivery network (including abstraction):

- Variable speed pumps;
- Water Tariffs changes;
- Pressure head delivery change.

Farmers level:

- From sprinkler to drip and from drip to subsurface;
- From full to Regulated Deficit Irrigation (RDI);
- From intensive to super intensive olive production;
- From intensive olive production to biological olive production;
- From sprinkler irrigation systems to variable rate irrigation systems (maize).



Example of Monte Novo Case Study

Monte Novo Irrigation Area – Example of results to be attained (technologies assessment)

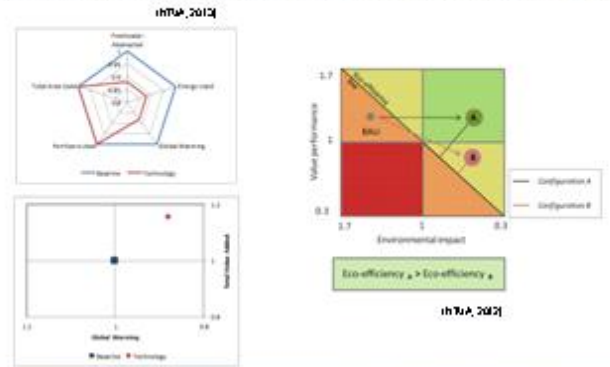

Actors and their different objectives

Directly and indirectly involved actors in the different system stages must be identified and described explaining the interactions among them, the pertinence to specific system components and stages and the links to eco-efficiency indicators.

- **Directly involved actors**, referring to the organizations and / or individuals that manage the corresponding stages (or elements), have direct economic benefits and costs, and take decisions.
- **Indirectly involved actors**, referring to Governmental institutions / authorities, consumers and further stakeholders who might benefit from or indirectly influence technology implementation and uptake.



Example of Monte Novo Case Study

Monte Novo Irrigation Area – Actors Involved

The actors involved in Monte Novo Irrigation Area at different levels (operation, management, agricultural production) include:

- **Indirect:**
 - Regional public institutions with responsibility in the water and agriculture sectors: River Basin District Administration of Alentejo (ARH - Alentejo) and Regional Directorate of Agriculture and Fisheries of Alentejo (DRAP - Alentejo).
- **Direct:**
 - The "Alentejo Development and Infrastructure Company" (EUA), whose main objective refers to the implementation and execution of the Alentejo Multi-annual Project (PMA).
 - The "Monte Novo Irrigation Scheme Users Association" (AMMonte Novo), endorsed to be responsible for the infrastructure management and water distribution of the Monte Novo public irrigation.
 - Local Agricultural SMEs (farmers) exploiting the irrigated areas.



Possible scenarios for Monte Novo area

- **Technology uptake for improved eco-efficiency:**
 - Water supply level (including possible management practices)
 - Farmers level
- **Scenarios:**
 - Political encouragement of resource efficiency
 - Accomplishment of strict environmental legislation
 - Economic constraints due to financial crisis
 - Social difficulties for technology uptake implementation
 - Environmental concerns due to intensive irrigation activities



Thank you for your attention



Tools to calculate meso-level Eco-efficiency indicators

18-04-2013
George Arampatzis
School of Chemical Engineering
National Technical University of Athens



EcoWater Tools and Toolbox

- SEAT - Systemic Environmental Analysis Tool
 - Evaluates flows of resources and emissions for environmental indicators
- EVAT - Economic Value Added Analysis Tool
 - Evaluates the value added from water use across the water value chain
- EcoWater Toolbox
 - A platform to assist the holistic evaluation of eco-efficiency and the assessment of innovative technology scenarios in water use systems

$$\text{Eco-efficiency metric} = \frac{\text{Economic output}}{\text{Environmental influence}}$$

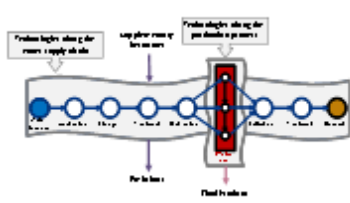

SEAT – Systemic Environmental Analysis Tool

Addresses the physical system, its components, processes & interactions

Allows the Specification

- System Mapping: Stages and Processes
- Material flows toward from each process
- Relates resource requirements flows for each material

Provides

- Flows of:
 - Water & effluents
 - Resources
 - Divisions
 - Products and by-products from water use
- How resources to be further assessed in the toolbox



The EcoWater Toolbox

A platform integrating

- Tools
- Data for water systems
- Inventories for technologies and indicators
- Procedures for:
 - Developing technology scenarios
 - Calculating eco-efficiency indicators
 - Comparing eco-efficiency performance of technology scenarios to the baseline results



EVAT – Economic Value Chain Analysis Tool

Addresses water value chain, its actors and their interactions

Allows the specification

- Mapping: Actors managing the stages of the system
- Financial costs: Investment, O&M, raw resources, sales for products
- Unit value of: Products and by-products
- Price of water services

Provides

- Distribution of costs and incomes among the chain stages and actors
- Net Economic surplus for individual actors
- Total value added from water use



Functionalities of the EcoWater Toolbox

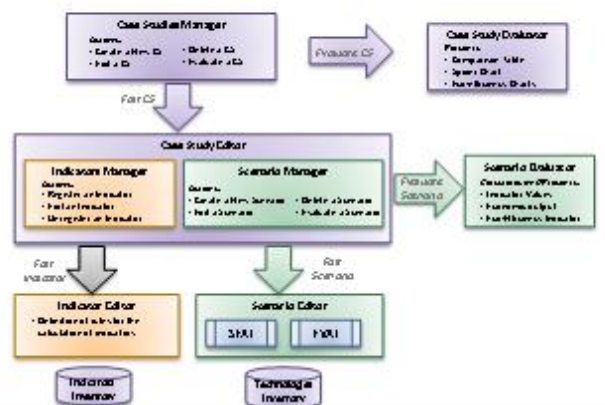

Outputs from Scenario Evaluation

Environmental Outputs

Resource Input and Emission Accounting



Economic Outputs

Financial Costs and Value of Products



Environmental Indicators

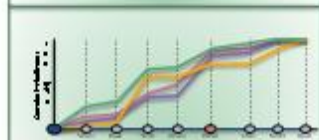

Net Economic Output of Actors

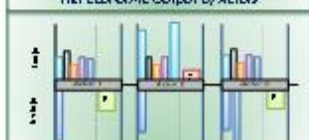

Outputs from Case Study Evaluation

Environmental Performance Comparison

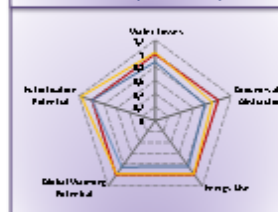

eco-efficiency Performance Comparison

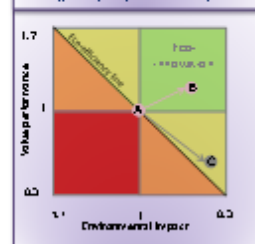

Demonstration of Tools and Toolbox

- Hands-on demonstration of the functionalities
- Monte Nava Case Study
- Develop and assess technology scenarios:
 - Sub-surface drip irrigation
 - Regulated Ditch Irrigation
- Discussion on the functionalities provided
- Feedback on possible changes/improvements

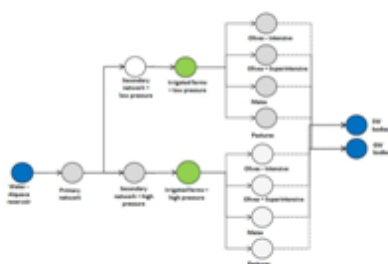

Volunteers ?

Thank you for your attention

For more information, see
<http://environ.chemeng.nyu.edu/labbox>
<http://environ.chemeng.nyu.edu/econvaler/>



Annex E: Presentations of session 3: FACILITATING WISE TECHNOLOGY DECISION MAKING: TECHNOLOGY ASSESSMENT, SCENARIO'S AND STAKEHOLDERS

Presentation: Overview of eco-innovative technologies in the EcoWater sectors. By Åsa Nilsson, IVL Swedish Environmental Research Institute, Sweden.

Overview of eco-innovative technologies in the EcoWater sectors

Åsa Nilsson
IVL Swedish Environmental Research Institute, Sweden



Content

- Introduction
- Technologies in the water value chain
- Technology data inventory
 - Generic structure of reference data
 - Parameter examples
- EcoWater technologies
 - Overview
 - Agricultural sector
- Conclusions



Introduction

- Selection of new technologies to be compared to Business As Usual
 - Likely to be more eco-efficient
 - The assessment will show if they are
- Information on technologies
 - Generic structure of data inventory
 - Different set of parameters between sectors
 - Technology data for the relevant subset of sectorial parameters



Technologies in the water value chain

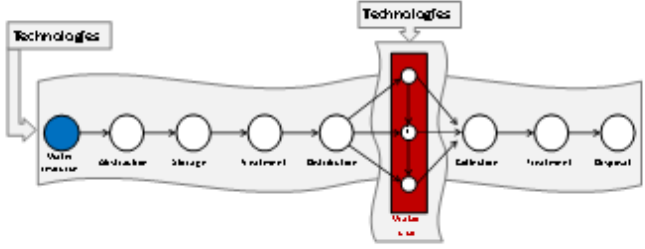

The diagram illustrates the water value chain as a sequence of stages: Water intake, Distribution, Storage, Treatment, Distribution, Collection, Treatment, and Disposal. A vertical red bar labeled 'Water' is overlaid on the 'Distribution' and 'Collection' stages, with 'Technologies' boxes above and below it, indicating the application of technologies at these stages.



Technology data inventory

Generic structure of reference data

| Common database fields | Technology performance parameters | | | Technology economic parameters | | | Technology environmental parameters | | | Technology efficiency parameters | | | Additional information |
|------------------------|-----------------------------------|-----|-----|--------------------------------|-----|-----|-------------------------------------|-----|-----|----------------------------------|-----|-----|------------------------|
| | Group | | | Group | | | Group | | | Group | | | |
| | Name | ... | ... | Name | ... | ... | Name | ... | ... | Name | ... | ... | |
| | Unit | ... | ... | Unit | ... | ... | Unit | ... | ... | Unit | ... | ... | Variable |
| x | x | x | x | x | x | x | x | x | x | x | x | x | x |
| x | x | x | x | x | x | x | x | x | x | x | x | x | x |
| x | x | x | x | x | x | x | x | x | x | x | x | x | x |
| x | x | x | x | x | x | x | x | x | x | x | x | x | x |

x = technology data/information

Technology data inventory

Parameter examples

- Economic parameters
 - Investment cost
 - Operation cost
 - Maintenance cost
- Environmental parameters
 - Water use
 - Water quality influence (e.g. Δ COD, Δ P)
 - Resource use (e.g. chemicals, energy carriers)
- Efficiency parameters
 - Energy use / volume of water

Technology

Ultrafiltration \Rightarrow drinking water

- 1.2 ME
- 0.12 €/m³
- 2.4 k€/yr
- 1.8 M m³/yr
- Almost complete removal of microbiological contaminants
- 15 MWh/yr (Electricity)
- 0.009 kWh/m³

EcoWater technologies

Overview

| TECHNOLOGIES IN INVENTORY | APPLICATION AREA | CASE STUDY |
|---------------------------|------------------|-----------------------------|
| 8 | Agricultural | Småland Grants, Motala News |
| 22 | Agricultural | Motala News |
| 14 | Urban | Soma |
| 32 | Urban | Zürich |
| 10 | Industrial | Fuchs |
| 10 | Industrial | Energy |
| 24 | Industrial | Umay |
| 12 | Industrial | Automotive |

EcoWater technologies

Agricultural sector

| INNOVATIVE TECHNOLOGIES | CASE STUDY |
|---|-----------------------------|
| Variable speed pumps | Småland Grants, Motala News |
| Non-borehole water delivery (Acqueduct) | Småland Grants |
| Variable flow water supply (demand based, energy produced) | Motala News |
| Shifting non-potable to pot. handling to sub-urban | Småland Grants, Motala News |
| Threatened delivery change | Motala News |
| Change from intensive to extensive production | Motala News |
| Change from intensive to biological production | Motala News |
| Change from drip irrigation system to variable irrigation system on maize | Motala News |
| Change from full irrigation to regulated deficit irrigation | Småland Grants, Motala News |
| Greenhouse gas production mitigation | Småland Grants |

Conclusions

EcoWater

- Provides a generic structure for collection of technology reference data
- Establishes a library of technology reference data based on 8 Case Studies, within Agricultural, Urban and Industrial water use applications.

Thank you!

Contact information:

Åsa Nilsson
asa.nilsson@ivl.se

Scenarios to support eco-innovation decisions

Palle Lindgaard-Jørgensen, PhD
DHI



Content

- Eco-efficiency
- Eco-innovation decisions studied
- Scenario frameworks
- Example- dairy industry
- conclusion





Eco-efficiency

- De-coupling resource use and environmental impact from economic activity
- Economic aspects (different ways to measure)
- Environmental aspects (different ways to measure)

• Eco-efficiency= $\frac{\text{Economic output}}{\text{Environmental impact}}$

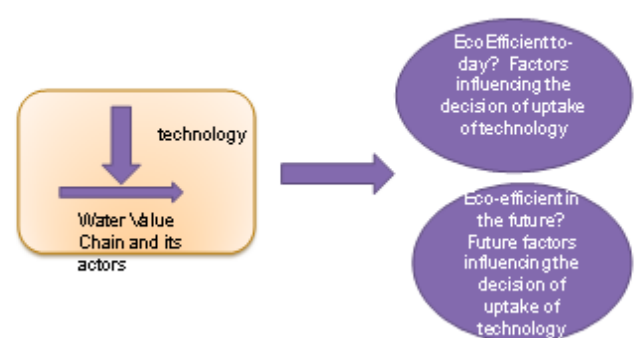

EcoWater Eco-innovation decisions support

EcoWater scenario frameworks to support eco-innovation decisions

- *Technology scenarios* to assess Eco-efficiency = economic value created by use of water divided by the impact
- Understanding interactions among actors in the value chain
- *Future scenarios* to analyse different plausible futures and what influences decisions on uptake of eco-efficient technologies



EcoWater Future Scenario Framework

- The PESTLE factors analysis (Political, Economic, Social, Technical, Legal and Environmental) is supported by an extended literature report on drivers and barriers (general and sector specific)
- Enables analysis of both macro-level influences (both drivers and barriers) and micro-level forces (drivers and barriers)
- Literature on already planned futures (like international and national targets) support a forecast of present drivers and barriers and develop plausible futures for analysis of eco-innovation decisions



A step-wise procedure

- Collect case specific information on actors directly and indirectly involved in the value chain of the case and how they interact
- Complement this list of drivers and barriers through a check of the list of general and sector specific drivers and barriers
- Develop the PESTLE analysis of factors. Include the most important and relevant drivers and barriers using tools like SWOT analysis and checks with actors to assess importance and relevance
- Analyse drivers and barriers- will they be more or less important in the future and what is the uncertainty in relation to direction size and form of the driver and barrier in the future
- Develop the plausible futures. Which factors constitute the most important drivers and barriers. Often this will be the economic and environmental factors.
- Analyse what may improve uptake/penetration of technologies in the each of the plausible futures
- Analyse how interactions with actors in the value chain and actors which are outside the boundaries may influence uptake/penetration

Most critical and important factors influencing the uptake of advanced membrane technology in the dairy industry

Advanced Membrane technologies Closed loop systems- independent of local availability of water

CSR- company Environmental Strategy is an important driver for the technology- reduced water use and environmental impacts – however high energy use

Advanced Membrane technology breakthrough- likely to happen- also with a lower energy use

Surplus of water cannot be used because of regulation of groundwater recharge

Conclusions and key messages

- Frameworks has been developed to analyse Eco-Innovation Technology choices and will be tested in EcoWater Case studies and strengthened
- Analysing barriers and drivers for uptake and penetration of eco-efficient technologies to-day and in a plausible future can support decisions on eco-efficient technologies
- Information from all eight case studies in Eco-water improve our understanding on incentives and regulatory measures for technology uptake

Assessing eco-innovative technologies in agriculture

Mladen Todorović, CIHEAM-MAI-Bari



EcoWater

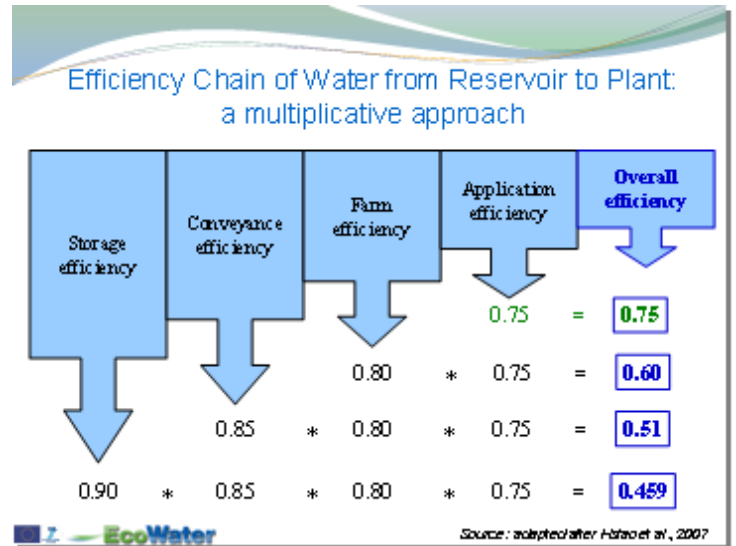
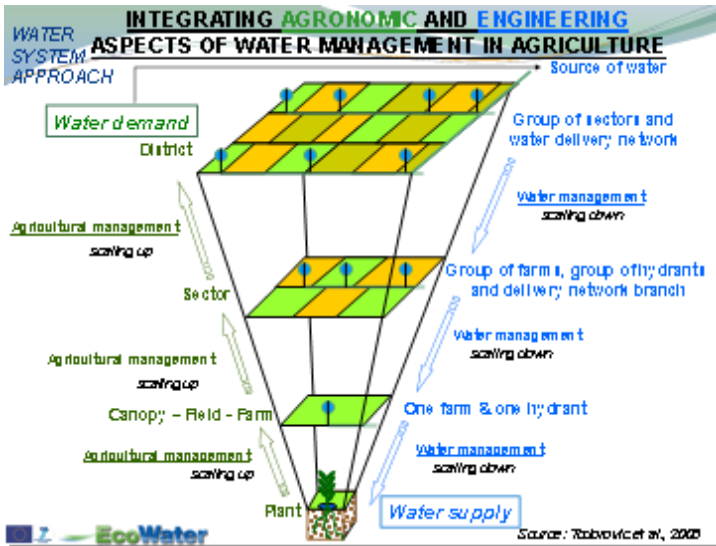
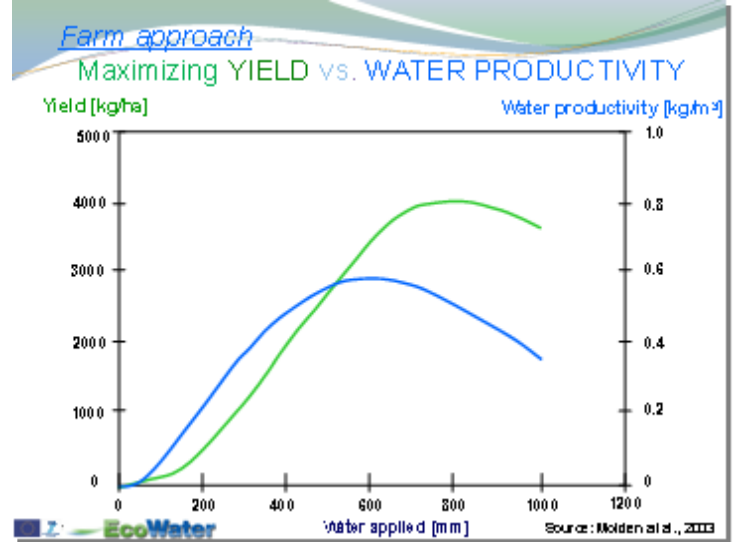

Water demand, supply & withdrawal

- Water Demand, WD

$$WD = \sum_{i=1}^n \left(\frac{ET_c - P_{eff}}{EFF_{app}} A \right)_i$$
- Water Supply, WS

$$WS = WD$$
- Water withdrawal, WW

$$WW = \frac{WD}{\prod_{j=1}^n EFF_j} = \frac{\sum_{i=1}^n \left(\frac{ET_c - P_{eff}}{EFF_{app}} A \right)_i}{\prod_{j=1}^n EFF_j} = \frac{\text{Agronomic demand}}{\text{Engineering Efficiency}}$$

EcoWater

Assessing Agricultural Eco-Efficiency

Product/Service value – cost of production/service (€)

↑

PRODUCT/SERVICE ADDED VALUE

↓

ENVIRONMENTAL IMPACT

Composite System Indicator

- Water withdrawal (m³)
- Groundwater withdrawal (m³)
- Energy consumption (kWh)
- Global Warming Potential (CO₂ eq. tons)
- Fertilizers (N, P) application (kg)

Resource Exploitation Indicator (threshold/barrier), REI
 $GW_REI = (GW_OUT) / (GW_IN)$

EcoWater

Eco-innovative technologies for agricultural water use



Remote automated control of irrigation water supply
 Devices for control of water withdrawal from aquifers
 Monitoring SPAC, better irrigation scheduling
 More efficient irrigation techniques (drip, subsurface)
Changes in cropping pattern
 Use of treated waste water



Solar-powered irrigation pumps
 Eco-friendly variable speed pumps
 Network sectoring and dynamic pressure regulation



Use of biodegradable mulches
 Application of minimum tillage
Changes in cropping pattern
 Organic Farming

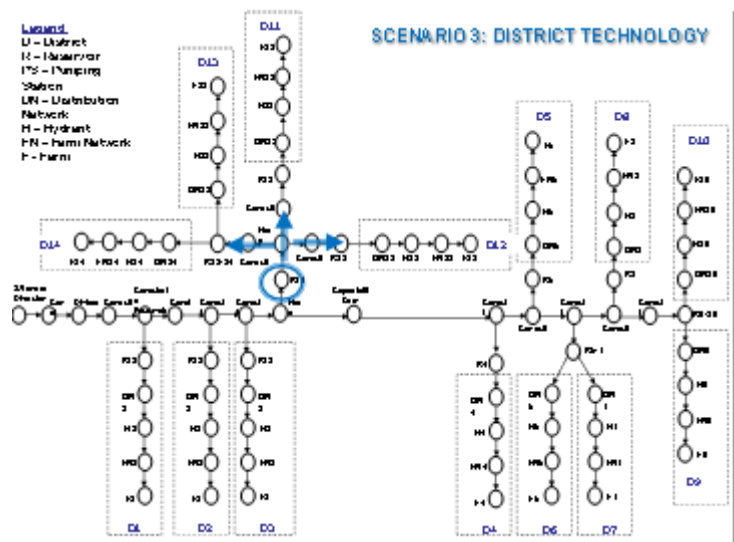
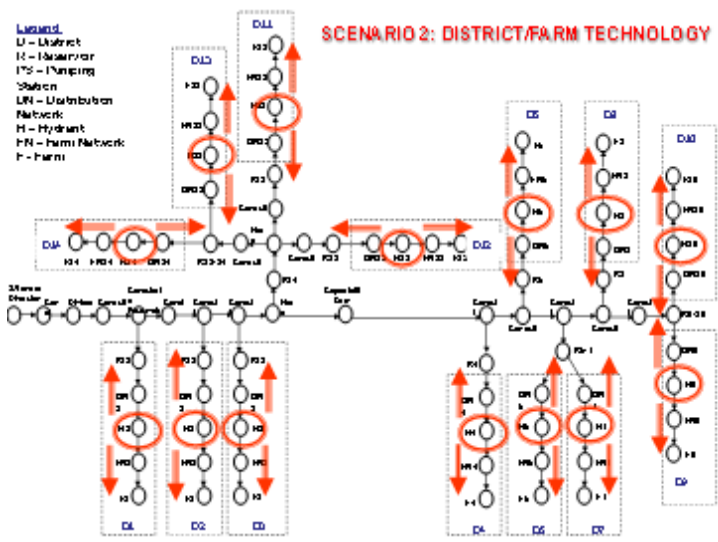
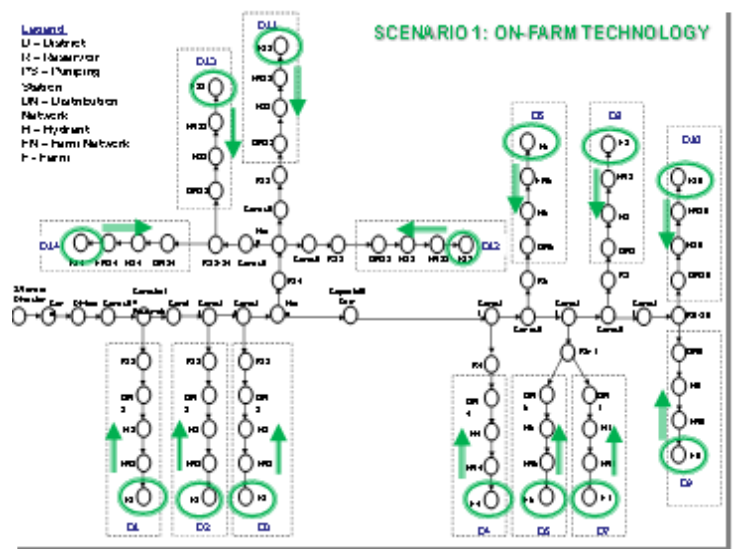
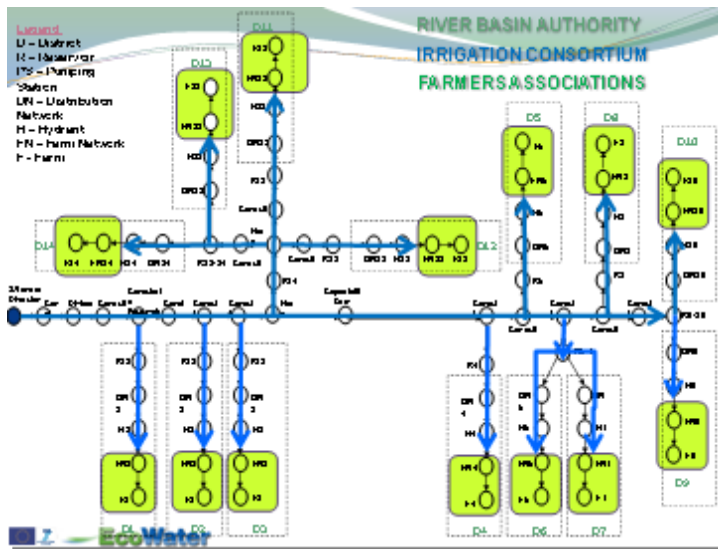
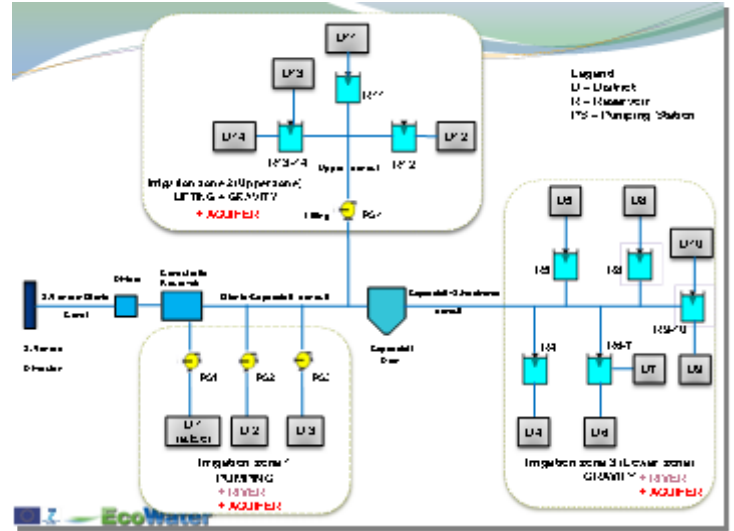

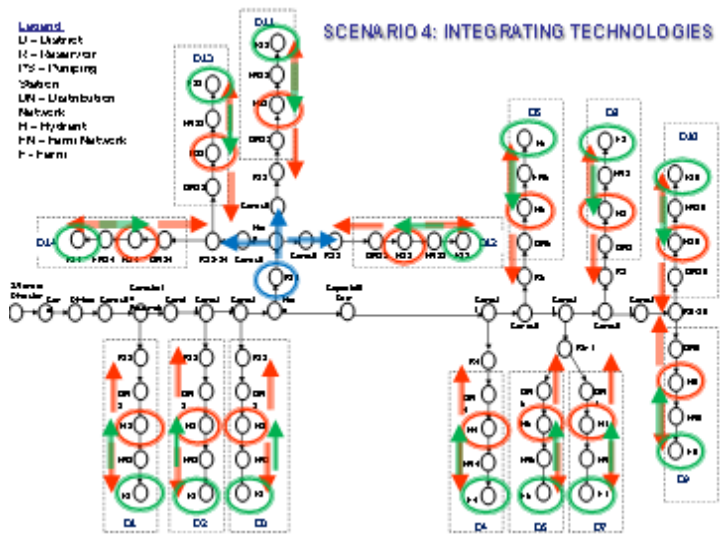

Integrating and automating ... a complex ADSS at farm and district scale

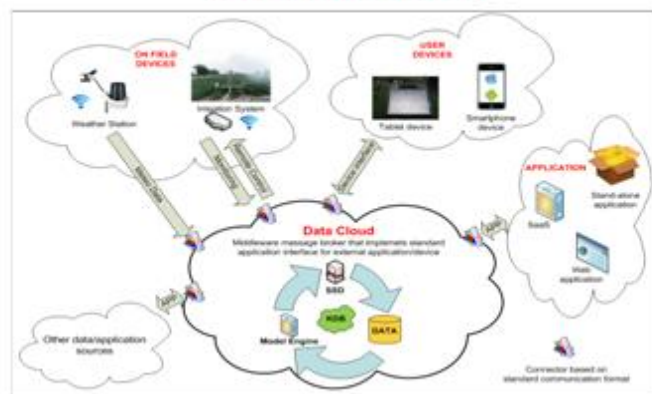

Examples of preliminary results environmental performance comparison

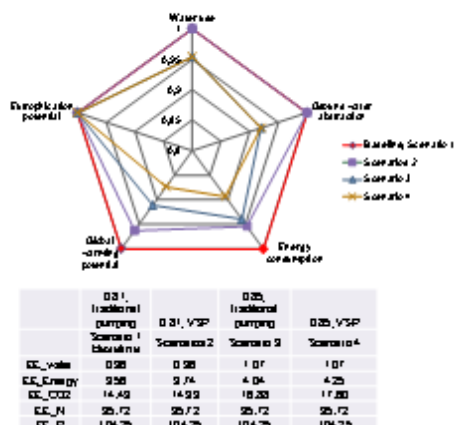

Conclusions

- **Selection/Uptake of technologies** ("plausible alternative futures") is site-specific – should consider both technical and PESTLE factors (drivers & barriers) at both micro, meso and macro scale
- **Technologies** could be applied/implemented/integrated at **different scales** (micro-farm, meso-district)
- **Indicators** should be quantitative, understandable, analogous, cumulative, dynamic, ... *composite*
- **Social and institutional (and policy)** dimensions are **not explicitly captured** in eco-efficiency measures – remain critical barriers and opportunities on the pathway toward more eco-efficient agriculture (Keating et al., 2010)... *PESTLE factors could be a tool to consider them*

Question of the scale?
 ... and of the point of view

www.cheam.org
www.iamb.it
 mladen@iamb.it





AquaConSoil
Barcelona
2013

The EU Environmental Technology Verification (ETV) Pilot Programme

Dr. Thomas Track
DECHEMA e.V., Frankfurt am Main, Germany

EU FP7 project „EcoWater“ – 18th April 2013 – AquaConSoil, Barcelona/Spain

Environmental Technology Verification – ETV

AquaConSoil
Barcelona
2013

ETV is to generate independent and credible information on new environmental technologies, by verifying that performance claims are complete, fair and based on reliable test results.



"It does what it says on the tin"

Help innovative environmental technologies reach the market

Adapted from ECDC Environment



Why ETV?

AquaConSoil
Barcelona
2013

"When approaching new markets we always have to repeat extensive testing and demonstration for our new biological off-gas treatment technologies as no testing framework exists." (SME, technology developer & provider)

"Our new measurement device is able to measure BOD5 with in a few hours instead of 5 days, but our performance data face problems in acceptance." (SME, technology developer & provider)

"As plant operator we could accept innovative, cost efficient technologies easier, if they could prove performance in a credible way" (industrial client)

"When we accept a new, not established environmental technology, we need to justify the decision against an established one properly" (industrial client)

"If performance of innovative technologies is proven in a reliable way, it would be easier for us to accept them" (industrial company, not a technology provider)



Why ETV? Increasing acceptance

AquaConSoil
Barcelona
2013



It's an innovation once it's accepted in the market



Policy context

AquaConSoil
Barcelona
2013

Innovation Union

turning ideas into jobs, green growth and social progress

- supporting companies, especially SMEs, to develop and market innovations
- European Innovation Partnerships, e.g. water.

Resource Efficiency Roadmap

transition towards a green economy: improving economic performance while reducing pressure on natural resources

- improving products, changing consumption patterns
- research and innovation to boost efficient production,
- sustaining eco-systems and protecting natural capital
- key sectors: food and drink, construction and transport

Adapted from ECDC Environment



Eco-innovation Action Plan

AquaConSoil
Barcelona
2013

Boosting innovation of benefit to the environment and bridging the gap between innovation and markets.

Main actions:

- Policy and legislation as drivers for eco-innovation
- Demonstration projects and partnerships
- New standards integrating eco-innovation; eco-design
- Financial instruments and support services for SMEs
- International co-operation
- Fostering emerging green skills and jobs

Adapted from ECDC Environment



Eco-innovation Action Plan

AquaConSoil
Barcelona
2013

Action 4: Finance and support services for SMEs

The European Commission will develop initiatives to improve confidence in new environmental technologies and eco-innovative solutions entering the EU and global markets,

informed by the results of an experimental voluntary pilot programme on environmental technology verification (ETV).

Adapted from EC DG Environment



Expected benefits of ETV

AquaConSoil
Barcelona
2013

For technology producers:

- Establishing trust with technology purchasers and users
- Facilitated access to markets, access to new markets (EU and abroad)

For technology purchasers / users:

- Easier comparison of technologies, facilitates informed decisions
- Facilitated access to innovative technologies, cost-efficient solutions

For policy-makers:

- Source of knowledge on technology performance, to inform regulation
- Cost-efficient solutions to address environmental challenges

Adapted from EC DG Environment



What technologies?

AquaConSoil
Barcelona
2013

New environmental technologies

- Performing better on environmental aspects than current alternatives;
- Going beyond applicable regulations and standards;
- Need for differentiation, credibility, visibility

Technology scope of ETV pilot programme

- Water technologies (monitoring, treatment)
- Materials, waste and resources (recycling, biomass)
- Energy technologies (renewables, efficiency, waste-to-energy)

Adapted from EC DG Environment



Outline ETV process

AquaConSoil
Barcelona
2013



Adapted from EC DG Environment



Costing and funding issues

AquaConSoil
Barcelona
2013

Wide-ranging estimates

- Highly variable
- Average cost for DANETV in 2009-2010
€28,000 verification procedures
€53,000 verification + testing

EU support to ETV pilot programme

- Overall co-ordination, Technical Working Groups
- Support to Verification Bodies

Direct support to companies

- Possible through EU programmes (FP7, CIP, LIFE+) or national funding schemes (grants, loans)



Adapted from EC DG Environment



ETV Cost - benefit

AquaConSoil
Barcelona
2013

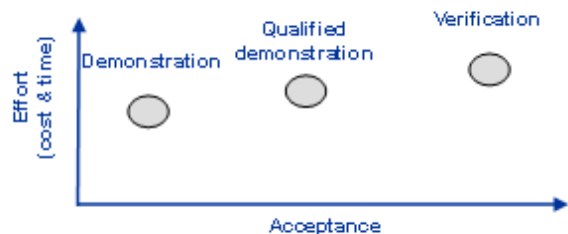

International co-operation on ETV

AquaConSoil
Barcelona
2013

International Working Group (IWG) on ETV:

Canada, EU, South Korea and the Philippines
– China, Japan and the USA are observers

Objective: to prepare the ground for mutual recognition of ETV programmes globally:

- Drafting of consensus policy documents on key aspects of ETV
- Facilitates joint and co-verification of technologies by 2 or more programmes
- Develops an ISO standard for environmental technology verification and reporting
- Organises international forums and workshops to engage stakeholders, promote the adoption and use of ETV globally

Adapted from ECOCG Environment



The market benefit

AquaConSoil
Barcelona
2013

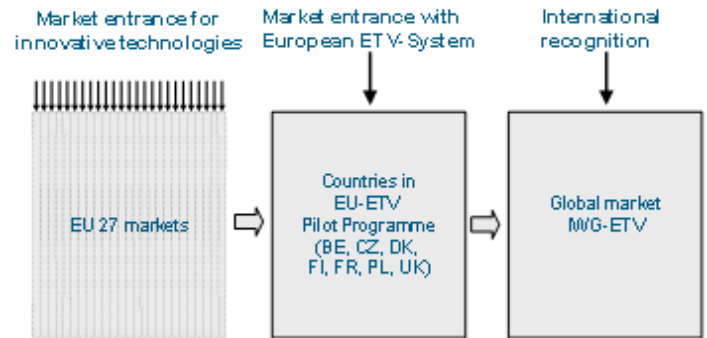

Thank you for your attention

For more information:

ENV-ETV@ec.europa.eu

<http://ec.europa.eu/environment/etv/index.htm>

AquaConSoil
Barcelona
2013



EcoWater



University of Applied Sciences and Arts Northwestern Switzerland
School of Life Sciences

FEUP FACULDADE DE ENGENHARIA
UNIVERSIDADE DO PORTO



IVL Swedish Environmental
Research Institute



IVL Swedish Environmental
Research Institute

IVL Swedish Environmental Research Institute Ltd., P.O. Box 210 60,
S-100 31 Stockholm, Sweden
Phone: +46-8-598 563 00 Fax: +46-8-598 563 90
www.ivl.se